

FUJITSU

OPERATING MANUAL

INVERTER

**HEAT & COOL MODEL
(REVERSE CYCLE)**

**ROOM AIR CONDITIONER
WALL MOUNTED TYPE**

**Indoor Unit
AST13PSA-W**

**Outdoor Unit
AOT13PNA**

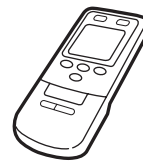
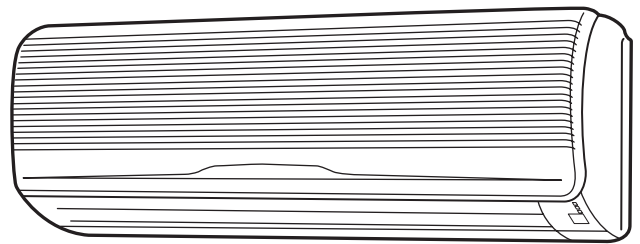

CONTENTS

SAFETY PRECAUTIONS	56	SWING OPERATION	66
NAME OF PARTS	57	MANUAL AUTO OPERATION	66
FEATURES AND FUNCTIONS	57	CLEANING AND CARE	67
PREPARATION	60	TROUBLESHOOTING	69
OPERATION	61	OPERATING TIPS	70
TIMER OPERATION	63	SPECIFICATIONS	71
SLEEP TIMER OPERATION	64		
ADJUSTING THE DIRECTION OF AIR CIRCULATION	65		

SAFETY PRECAUTIONS

WARNING!

- If the power supply code of this air conditioner is damaged, it must be replaced by the manufacturer or its authorized service personnel only in order to avoid a safety hazard.

DANGER!

- Do not attempt to install this air conditioner by yourself.
- This unit contains no user-serviceable parts. Always consult authorized service personnel for repairs.
- When moving, consult authorized service personnel for disconnection and installation of the unit.
- Do not become excessively chilled by staying for lengthy period in the direct cooling airflow.
- Do not insert fingers or objects into the outlet port or intake grilles.
- Do not start and stop air conditioner operation by disconnecting the power supply cord and so on.
- Take care not to damage the power supply cord.
- In the event of a malfunction (burning smell, etc.), immediately stop operation, turn off the circuit breaker, and consult authorized service personnel.

CAUTION!

- Provide occasional ventilation during use.
- Do not direct air flow at fireplaces or heating apparatus.
- Do not climb on, or place objects on, the air conditioner.
- Do not hang objects from the indoor unit.
- Do not set flower vases or water containers on top of air conditioners.
- Do not expose the air conditioner directly to water.
- Do not operate the air conditioner with wet hands.
- Do not pull power supply cord.
- Turn off power source when not using the unit for extended periods.
- Check the condition of the installation stand for damage.
- Do not place animals or plants in the direct path of the air flow.
- Do not drink the water drained from the air conditioner.
- Do not use in applications involving the storage of foods, plants or animals, precision equipment, or art works.
- Connection valves become hot during Heating; handle with care.
- Do not apply any heavy pressure to radiator fins.
- Operate only with air filters installed.
- Do not block or cover the intake grille and outlet port.
- Ensure that any electronic equipment is at least one meter away from either the indoor or outdoor units.
- Avoid installing the air conditioner near a fireplace or other heating apparatus.
- When installing the indoor and outdoor unit, take precautions to prevent access to infants.
- Do not use inflammable gases near the air conditioner.

NAME OF PARTS

Fig. 1 Indoor Unit

- ① **Operating Control Panel (Fig. 2)**
- ② **MANUAL AUTO button**

- ③ **Remote Control Signal Receiver**

- ④ **Indicator lamps (Fig. 3)**
- ⑤ **OPERATION Indicator Lamp (red)**
- ⑥ **TIMER Indicator Lamp (green)**
 - If the TIMER Indicator Lamp flashes when the timer is operating, it indicates that a fault has occurred with the timer setting (See Page 70 Auto Restart).

- ⑦ **SWING Indicator Lamp (orange)**
- ⑧ **Intake Grille (Fig. 4)**
- ⑨ **Air Filter**
- ⑩ **Air Flow Direction Louver**
- ⑪ **Right-Left Louvers (behind Air Flow Direction Louver)**
- ⑫ **Drain Hose**
- ⑬ **Power Supply Plug**
- ⑭ **Power Supply Cord**
- ⑮ **Air Cleaning Filter (optional)**

Fig. 5 Outdoor Unit

- ⑯ **Intake Port**
- ⑰ **Outlet Port**
- ⑱ **Pipe Unit**
- ⑲ **Drain port (bottom)**

Fig. 6 Remote Control Unit

- ⑳ **SLEEP button**
- ㉑ **MASTER CONTROL button**
- ㉒ **SET TEMP. / SET TIME button (⊕ / ⊖)**
- ㉓ **Signal Transmitter**
- ㉔ **TIMER button**
- ㉕ **FAN CONTROL button**
- ㉖ **START / STOP button**
- ㉗ **AIR FLOW DIRECTION button**
- ㉘ **SWING LOUVER button**

Rear side (Fig. 7)

- ㉙ **TIME ADJUST button**
- ㉚ **ACL button (located inside battery compartment)**
- ㉛ **TEST RUN button**
 - This button is used when installing the unit, and should not be used under normal conditions, as it will cause the air conditioner's thermostat function to operate incorrectly.
 - If this button is pressed during normal operation, the unit will switch to test operation mode, and the Indoor Unit's OPERATION Indicator Lamp and TIMER Indicator Lamp will begin to flash simultaneously.
 - To stop the test operation mode, press the START / STOP button to stop the air conditioner.

- ㉜ **Remote Control Unit Display (Fig. 8)**
- ㉝ **Transmit Indicator**
- ㉞ **Clock Display**
- ㉟ **Operating Mode Display**
- ㊱ **Timer Mode Display**
- ㊲ **Fan Speed Display**
- ㊳ **Temperature Set Display**
- ㊴ **Timer Set Indicator**
- ㊵ **Temperature Set Indicator**

Fig. 1

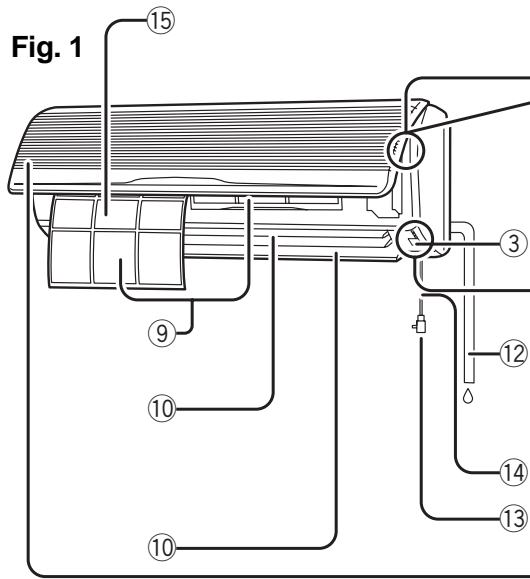

Fig. 2

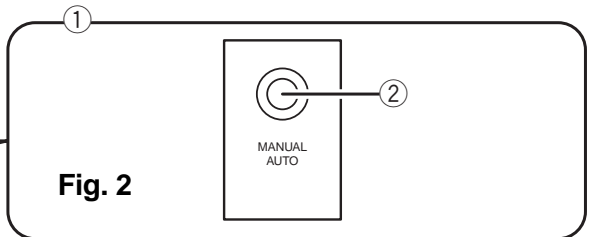

Fig. 3

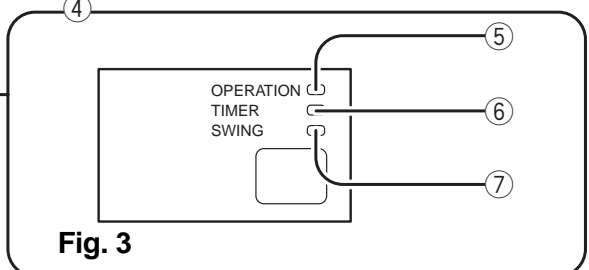

Fig. 4

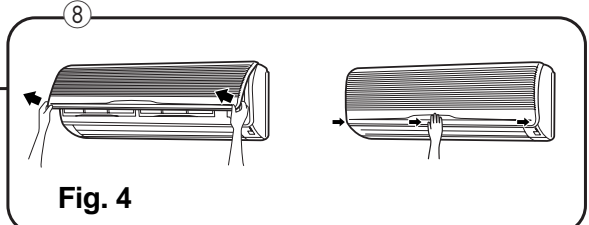

Fig. 5

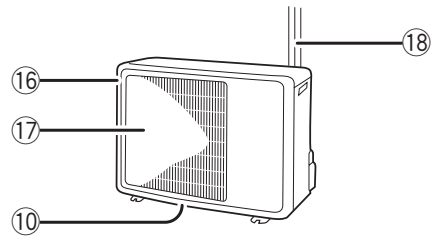

Fig. 6

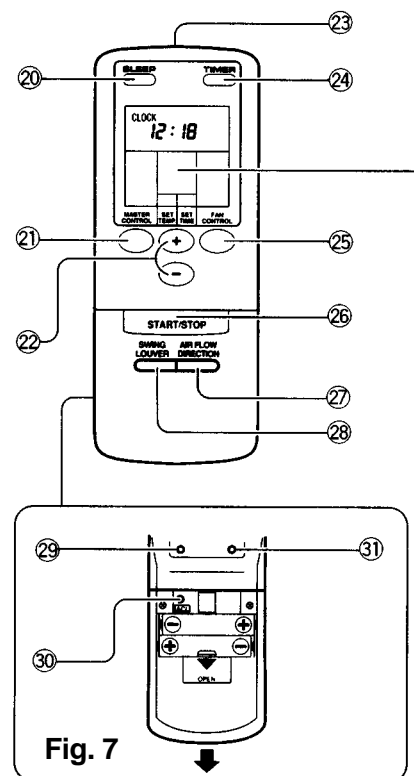
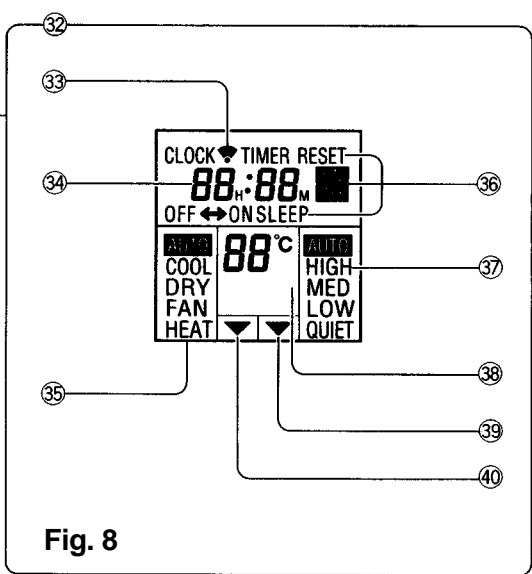

Fig. 8



FEATURES AND FUNCTIONS

INVERTER

At the start of operation, a large power is used to bring the room quickly to the desired temperature. Afterwards, the unit automatically switches to a low power setting for economic and comfortable operation.

AUTO CHANGEROVER

The operation mode (cooling, dry, and heating) is switched automatically to maintain the set temperature, and the temperature is kept constant at all times.

SLEEP TIMER

When the SLEEP timer button is pressed during heating mode, the air conditioner's thermostat setting is gradually lowered during the period of operation; during cooling mode, the thermostat setting is gradually raised during the period of operation. When the set time is reached, the unit automatically turns off.

WIRELESS REMOTE CONTROL UNIT

The WIRELESS REMOTE CONTROL UNIT allows convenient control of air conditioner operation.

SWING OPERATION

The Air Flow Direction Louvers swings automatically up and down so that the air speeds to every nock and corner of your room.

REMOVABLE INTAKE GRILLE

The indoor unit's INTAKE GRILLE can be removed for easy cleaning and maintenance.

MILDEW-RESISTANT FILTER

The AIR FILTER has been treated to resist mildew growth, thus allowing cleaner use and easier care.

SUPER QUIET OPERATION

When the FAN CONTROL button is used to select QUIET, the unit begins super-quiet operation; the indoor unit's airflow is reduced for quieter operation.

AIR CLEANING FILTER (Optional)

The optional Air Cleaning Filter (Model APS-03D) uses an electrostatic principle to clean the air of fine particulate matter such as tobacco smoke and plant pollen.

PREPARATION

Turn on the power

Connect the Power Supply Plug (Fig. 1 ⑬) to an electrical outlet; in the case of a direct line connection, turn on the circuit breaker.

Load Batteries (R03 / LR03 x 2)

1 Press and slide the battery compartment lid on the reverse side to open it.

Slide in the direction of the arrow while pressing the  mark.

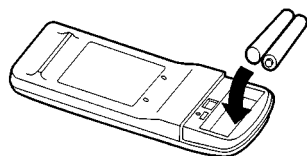

2 Insert batteries.

Be sure to align the battery polarities (\oplus/\ominus) correctly.

3 Close the battery compartment lid.

Set the Current Time

1 Press the TIME ADJUST button (Fig. 7 ⑲)

Use the tip of a ball-point pen or other small object to press the button.

2 Use the \oplus / \ominus SET TEMP. SET TIME buttons (Fig. 6 ⑳) to adjust the clock to the current time

\oplus button : Press to advance the time.

\ominus button : Press to reverse the time.

(Each time the buttons are pressed, the time will be advanced / reversed in one-minute steps; hold the buttons depressed to change the time quickly in ten-minute steps).

3 Press the TIME ADJUST button again.

This completes the time setting and starts the clock.

To Use the Remote Control Unit

- The Remote Control Unit must be pointed at signal receiver (Fig. 1 ③) to operate correctly.
- Operating Range: About 7 meters.
- When a signal is properly received by the air conditioner, a beeping sound will be heard.
- If no beep is heard, press the Remote Control Unit button again.

Remote Control Unit Holder

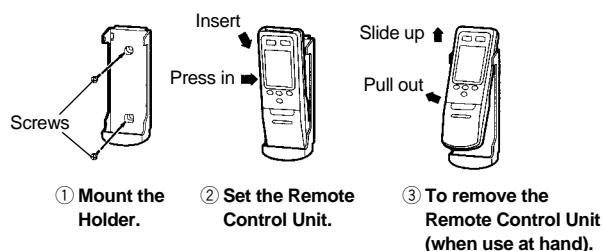

CAUTION

- Take care to prevent infants from accidentally swallowing batteries.
- When not using the remote control unit for an extended period, remove the batteries to avoid possible leakage and damage to the unit.
- If leakage battery fluid comes in contact with your skin, eyes, or mouth, immediately wash with copious amounts of water, and consult your physician.
- Dead batteries should be removed quickly and disposed of properly, either by placing in a public battery collection receptacle, or by returning to appropriate authority.
- Do not attempt to recharge dry batteries.

Never mix new and used batteries, or batteries of different types.

Batteries should last about one year under normal use. If the remote control unit's operating range becomes appreciably reduced, replace the batteries and press the ACL button with the tip of a ball-point pen or other small object.

OPERATION

To Select Mode Operation

1 Press the START / STOP button (Fig. 6 26).

The Indoor Unit's OPERATION Indicator Lamp (red) (Fig. 3 5) will light.

The air conditioner will start operation.

2 Press the MASTER CONTROL button (Fig. 6 21) to select the desired mode.

Each time the button is pressed, the mode will change in the following order.

About three seconds later, the entire display will reappear.

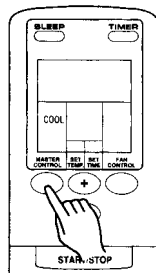

Example :
When set to COOL

To Set Thermostat

Press the SET TEMP. SET TIME button (Fig. 6 22).

⊕ button : Press to raise the thermostat setting.

⊖ button : Press to lower the thermostat setting.

• Thermostat setting range:

AUTO 18 to 30°C

Heating 16 to 30°C

Cooling/Dry 18 to 30°C

About three seconds later, the entire display will reappear.

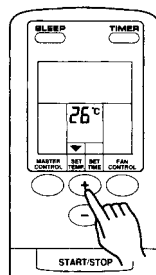

Example :
When set to 26 °C

The thermostat setting should be considered a standard value, and may differ somewhat from the actual room temperature.

To Set the Fan Speed

Press the FAN CONTROL button (Fig. 6 25).

Each time the button is pressed, the fan speed changes in the following order.



About three seconds later, the entire display will reappear.

When set to AUTO :

Heating :

Fan operates so as to optimally circulate warmed air.

However, the fan will operate at very low speed when the temperature of the air issued from the indoor unit is low.

Cooling :

As the room temperature approached that of the thermostat setting, the fan speed becomes slower.

Fan :

The fan alternately turns on and off; when on, the fan runs at the low fan speed.

The fan will operate at very low setting during Monitor operation and at the start of the Heating mode.

When set to QUIET:

SUPER QUIET operation begins. The indoor unit's air-flow will be reduced for quieter operation.

- SUPER QUIET operation cannot be used during Dry mode. (The same is true when Dry mode is selected during AUTO mode operation.)
- During SUPER QUIET operation, Heating and Cooling performance will be reduced somewhat.

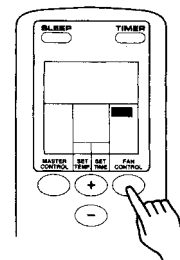

Example :
When set to COOL

In order to increase the drying effect during quiet cooling operation, the fan of the indoor unit may stop.

OPERATION

To Stop Operation

Press the START/STOP button.

The OPERATION indicator lamp (red) (Fig. 3 ⑤) will go out.

About AUTO CHANGEOVER Operation

AUTO :

- When AUTO CHANGEOVER operation first selected, the fan will operate at very low speed for about one minute, during which time the unit detects the room conditions and selects the proper operating mode.

If the difference between thermostat setting and actual room temperature is more than $+2^{\circ}\text{C}$ → Cooling or dry operation

When the outside temperature is lower than 10°C , cooling or dry mode operation is not performed. → Monitor operation

If the difference between thermostat setting and actual room temperature is within $\pm 2^{\circ}\text{C}$ → Monitor operation

If the difference between thermostat setting and actual room temperature is more than -2°C → Heating operation

When the outside temperature is higher than 20°C , heating operation is not performed. → Monitor operation

- When the air conditioner has adjusted your room's temperature to near the thermostat setting, it will begin monitor operation. In the monitor operation mode, the fan will operate at low speed. If the room temperature subsequently changes, the air conditioner will once again select the appropriate operation (Heating, Cooling) to adjust the temperature to the value set in the thermostat.
(The monitor operation range is $\pm 2^{\circ}\text{C}$ relative to the thermostat setting.)
- If the mode automatically selected by the unit is not what you wish, select one of the mode operation (HEAT, COOL, DRY, FAN).

About Mode Operation

Heating :

- Use to warm your room.
- When Heating mode is selected, the air conditioner will operate at very low fan speed for about 3 to 5 minutes, after which it will switch to the selected fan setting. This period of time is provided to allow the indoor unit to warm up before begin full operation.
- When the room temperature is very low, frost may form on the outside unit, and its performance may be reduced. In order to remove such frost, the unit will automatically enter the defrost cycle from time to time. During Automatic Defrosting operation, the OPERATION indicator Lamp (red) will flash, and the heat operation will be interrupted.

Cooling :

- Use to cool your room.

Dry :

- Use for gently cooling while dehumidifying your room.
- You cannot heat the room during Dry mode.
- During Dry mode, the unit will operate at low speed; in order to adjust room humidity, the indoor unit's fan may stop from time to time. Also, the fan may operate at very low speed when adjusting room humidity.
- The fan speed cannot be changed manually when Dry mode has been selected.

Fan :

- Use to circulate the air throughout your room.

During Heating mode :

Set the thermostat to a temperature setting that is higher than the current room temperature. The Heating mode will not operate if the thermostat is set lower than the actual room temperature.

During Cooling/Dry mode :

Set the thermostat to a temperature setting that is lower than the current room temperature. The Cooling and Dry modes will not operate if the thermostat is set higher than the actual room temperature (in Cooling mode, the fan alone will operate).

During Fan mode :

You can not use the unit to heat and cool your room.

TIMER OPERATION

Before using the timer function, be sure that the Remote Control Unit is set to the correct current time (See Page 60).

To Use the ON timer or OFF timer

1 Press the START/STOP button (Fig. 6 ㉔). (if the unit is already operating, proceed to step 2).

The indoor unit's OPERATION Indicator Lamp (red) (Fig. 3. ㉕) lights and the TIMER Indicator Lamp (green) (Fig. 3. ㉖) light.

• To Cancel the Timer

Use the TIMER button to select "TIMER RESET."
The air conditioner will return to normal operation.

2 Press the TIMER button (Fig. 6 ㉔) to select the OFF timer or ON timer operation.

Each time the button is pressed the timer function changes in the following order :

The indoor unit's TIMER Indicator lamp (green) (Fig. 3 ㉖) will light.

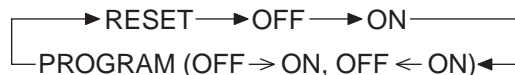

• To Change the Timer Setting

Perform steps 2 and 3.

• To Stop Air Conditioner Operation while the Timer is Operating

Press the START/STOP button.

3 Use the SET TEMP.SET TIME button (Fig. 6 ㉔) to adjust the desired OFF time or ON time.

Set the time while the time display is flashing (the flashing will continue for about five seconds).

⊕ **button** : Press to advance the time.

⊖ **button** : Press to reverse the time.

About five seconds later, the entire display will reappear.

• To Change Operating Conditions

If you wish to change operating conditions (Mode, Fan Speed, Thermostat Setting), after making the timer setting wait until the entire display reappears, then press the appropriate buttons to change the operating condition desired.

About the Program timer

- The PROGRAM timer allows you to integrate OFF timer and ON timer operations in a single sequence. The sequence can involve one transition from OFF timer to ON timer, or from ON timer to OFF timer, within a twenty-four hour period.
- The first timer function to operate will be the one set nearest to the current time. The order of operation is indicated by the arrow in the Remote Control Unit's display (OFF → ON, or OFF ← ON).
- One example of Program timer use might be to have the air conditioner automatically stop (OFF timer) after you go to sleep, then start (ON timer) automatically in the morning before you arise.

To Use the Program timer

1 Press the START/STOP button (Fig. 6 ㉔). (if the unit is already operating, proceed to step 2).

The indoor unit's OPERATION Indicator Lamp (red) (Fig. 3 ㉕) will light.

• To Cancel the Timer

Use the TIMER button to select "TIMER RESET."
The air conditioner will return to normal operation.

2 Set the desired times for OFF timer and ON timer.

See the section "To Use the ON Timer or OFF Timer" to set the desired mode and times.

About three seconds later, the entire display will reappear.

The indoor unit's TIMER Indicator Lamp (green) (Fig. 3 ㉖) will light.

• To Change the Timer Setting

1. Follow the instructions given in the section "To Use the ON Timer or OFF Timer" to select the timer setting you wish to change.

2. Press the TIMER button to select either OFF → ON or OFF ← ON.

3 Press the TIMER button (Fig. 6 ㉔) to select the PROGRAM timer operation (either OFF → ON or OFF ← ON will display).

The display will alternately show "OFF timer" and "ON timer", then change to show the time setting for the operation to occur first.

- The PROGRAM timer will begin operation. (If the ON timer has been selected to operate first, the unit will stop operating at this point).

About five seconds later, the entire display will reappear.

• To Stop Air Conditioner Operation while the Timer is Operating

Press the START/STOP button.

• To Change Operating Conditions

If you wish to change operating conditions (Mode, Fan Speed, Thermostat Setting), after making the timer setting wait until the entire display reappears, then press the appropriate buttons to change the operating condition desired.

SLEEP TIMER OPERATION

Unlike other timer functions, the SLEEP timer is used to set the length of time until air conditioner operation is stopped.

To Use the SLEEP Timer

While the air conditioner is operating or stopped, press the SLEEP button (Fig. 6 ⑤).

The indoor unit's OPERATION Indicator Lamp (red) (Fig.3 ⑤) will light.

- **To Cancel the Timer**
Use the TIMER button to select "TIMER RESET."
The air conditioner will return to normal operation.

To Change the Timer Setting

Press the SLEEP button (Fig 6. ②) once again and set the time using the SET TIME buttons (Fig 6. ②).

Set the time while the Timer Mode Display is flashing (the flashing will continue about five seconds).

- ⊕ **button** : Press to advance the time.
- ⊖ **button** : Press to reverse the time.

About five seconds later, the entire display will reappear.

- **To Stop the Air Conditioner During Timer Operation:**
Press the START/STOP button.

About the SLEEP Timer

To prevent excessive warming or cooling during sleep, the SLEEP timer function automatically modifies the thermostat setting in accordance with the time setting. When the set time has elapsed, the air conditioner completely stops.

During Heating operation :

When the SLEEP timer is set, the thermostat setting is automatically lowered 1°C every thirty minutes. When the thermostat has been lowered a total of 4°C, the thermostat setting at that time is maintained until the set time has elapsed, at which time the air conditioner automatically turns off.

- **SLEEP timer setting**

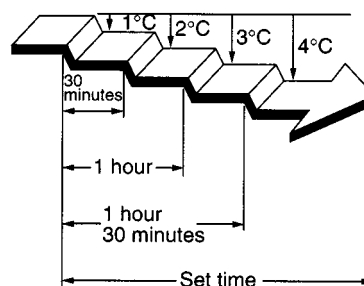

During Cooling/Dry operation :

When the SLEEP timer is set, the thermostat setting is automatically raised 1°C every sixty minutes. When the thermostat has been raised a total of 2°C, the thermostat setting at that time is maintained until the set time has elapsed, at which time the air conditioner automatically turns off.

- **SLEEP timer setting**

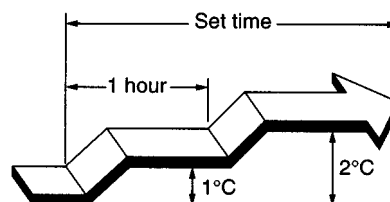

ADJUSTING THE DIRECTION OF AIR CIRCULATION

Vertical (up-down) direction of airflow is adjusted by pressing the Remote Control Unit's AIR FLOW DIRECTION button.

Horizontal (right-left) airflow direction is adjusted manually, by moving the Air Flow Direction Louvers.

Whenever making horizontal airflow adjustments, start air conditioner operation and be sure that the vertical air direction louvers are stopped.

Vertical Air Direction Adjustment

Press the AIR FLOW DIRECTION button (Fig.6 27).

Each time the button is pressed, the air direction range will change as follows:

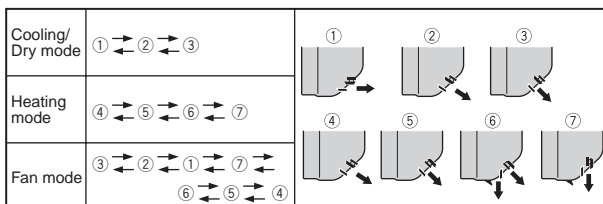

- Use the air direction adjustments within the ranges shown above.
- The vertical airflow direction is set automatically as shown, in accordance with the type of operation selected.

During Cooling/Dry mode : Horizontal flow ①

During Heating mode : Downward flow ⑥

- During Auto Changeover operation, the position of the air flow direction louvers will change automatically in accordance with the selected mode.
- If you wish to select a different airflow direction, you may use the remote control unit's AIR FLOW DIRECTION button to choose a different setting.
- When the temperature of the air being blown out is low at the start of heating operation or during defrosting, the airflow direction temporarily becomes ⑦ to prevent cold air being blown onto the body.
- When the AIR FLOW DIRECTION button of the remote control unit is pressed, some time is required until the airflow direction louvers reach the desired position.

During this time, adjustment of the airflow direction is not possible even when the AIR FLOW DIRECTION button is pressed.

- During Monitor operation in AUTO CHANGEOVER mode, the airflow direction automatically becomes ①, and it can not be adjusted.

- Always use the remote control unit's AIR FLOW DIRECTION button to adjust the vertical airflow louvers. Attempting to move them manually could result in improper operation; in this case, stop operation and restart. The louvers should begin to operate properly again.
- When used in a room with infants, children, elderly or sick persons, the air direction and room temperature should be considered carefully when making settings.

- Always use the remote control unit's AIR FLOW DIRECTION button to adjust the vertical airflow louvers. Attempting to move them manually could result in improper operation; in this case, stop operation and restart. The louvers should begin to operate properly again.
- When used in a room with infants, children, elderly or sick persons, the air direction and room temperature should be considered carefully when making settings.

Right-Left Adjustment

Adjust the Right-Left Louvers

- Move the Right-Left Louvers to adjust air flow in the direction you prefer.

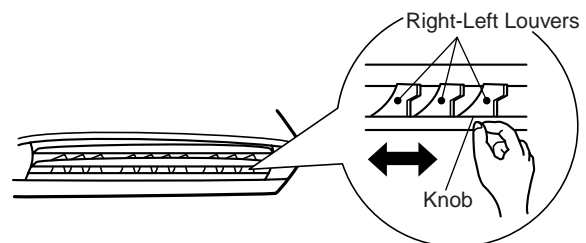

⚠ DANGER

- Never place fingers or foreign objects inside the outlet ports, since the internal fan operates at high speed and could cause personal injury.

SWING OPERATION

Begin air conditioner operation before performing this procedure.

To Select SWING Operation

Press the **SWING LOUVER** button (Fig. 6 ⑳).

The SWING Indicator Lamp (orange) (Fig. 3 ⑦) will light.

In this mode, the Air Flow Direction Louvers will swing automatically to direct the airflow both up and down.

To Stop SWING Operation

Press the **SWING LOUVER** button (Fig.6 ㉑) once again.

The SWING Indicator Lamp (orange) (Fig. 3 ⑦) will go out.

Airflow direction will return to the setting before swing was begun.

About Swing Operation

- The SWING range is as follows :

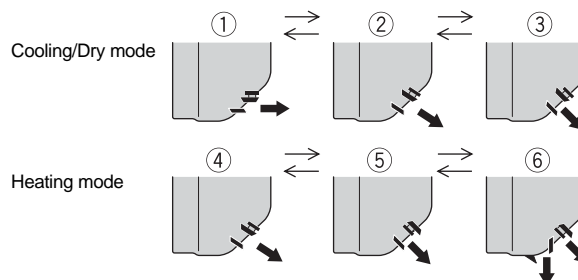

- The SWING operation may stop temporarily when the air conditioner's fan is not operating or when operating at very low speeds.
- The airflow direction can not be adjusted during SWING operation even when the AIR FLOW DIRECTION button is pressed.

MANUAL AUTO OPERATION

Use the MANUAL AUTO operation in the event the Remote Control Unit is lost or otherwise unavailable.

How to Use the Main Unit Controls

Press the **MANUAL AUTO** button (Fig. 2 ㉒) on the main unit control panel.

To stop operation, press the MANUAL AUTO button once again.

(Controls are located inside the Intake Grille)

- When the air conditioner is operated with the controls on the Main Unit, it will operate under the same mode as the AUTO CHANGEOVER mode selected on the Remote Control Unit (see page 64).
- During MANUAL AUTO operation, the thermostat is automatically set at a standard temperature setting (= 24°C).
- The fan speed selected will be "AUTO", and the airflow direction will be the standard direction (cooling: q, heating: y).

CLEANING AND CARE

⚠ CAUTION

- Before cleaning the air conditioner, be sure to turn it off and disconnect the Power Supply Cord.
- Be sure the Intake Grille (Fig. 4 ⑧) is installed securely.
- When removing and replacing the air filters, be sure not to touch the heat exchanger, as personal injury may result.

Cleaning the Intake Grille

1 Open the Intake Grille.

- ① Place your fingers at both lower ends of the grille panel, and lift forward; if the grille seems to catch partway through its movement, continue lifting upward to remove.
- ② Pull past the intermediate catch and open the Intake Grille wide so that it becomes horizontal.

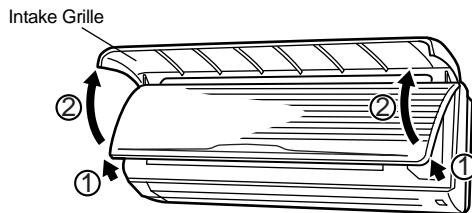

2 Unlock the Intake Grille.

Hold the Intake Grille with one hand and pull the Knobs on the right and the left all the way to unlock the Intake Grille.

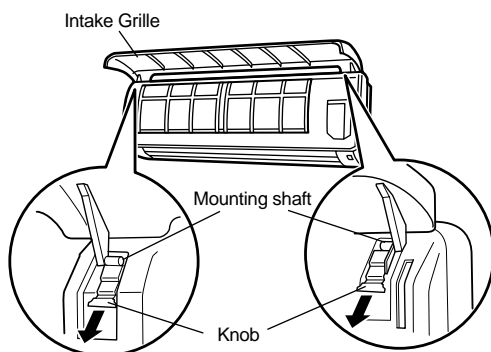

Raise the horizontal Intake Grille to remove it.

3 Clean with water.

Remove dust with a vacuum cleaner : wipe the unit with warm water, then dry with a clean, soft cloth.

4 Set the mounting shaft of the Intake Grille into the bearings at the top of the panel.

- ① Pull the Knobs all the way.
- ② Hold the grille horizontal and set the left and right mounting shafts into the bearings at the top of the panel.

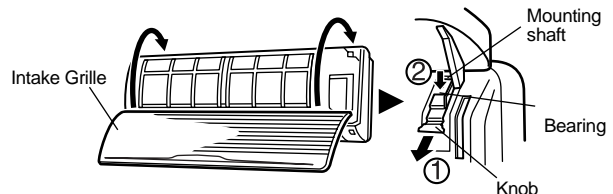

5 Lock the Intake Grille.

Hold the Intake Grille with one hand and push the Knobs on the right and the left all the way in to lock the Intake Grille mounting shafts.

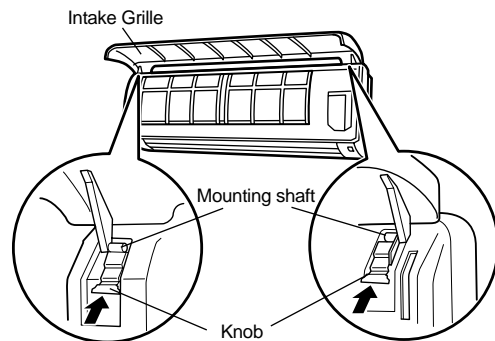

6 Close the Intake Grille.

Push the lower edge of the Intake Grille at both ends and at the center to close it.

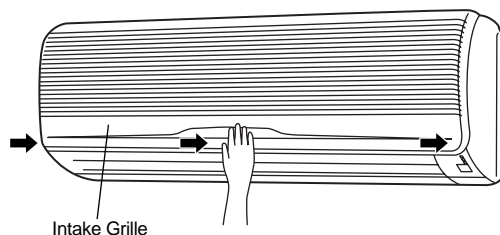

⚠ CAUTION

Do not operate with open Intake Grille, as this can cause accidents.

CLEANING AND CARE

Cleaning the Air Filter

1 Open the Intake Grille, and remove the air Filter.

Lift up the air filter's handle, disconnect the two lower tabs and pull out.

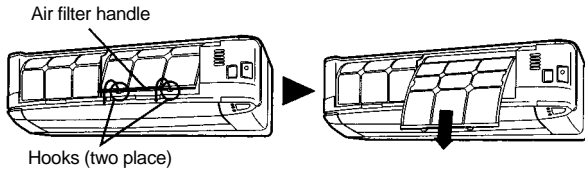

2 Remove dust with a vacuum cleaner or by washing.

After washing, allow to dry thoroughly in a shaded place.

Replace the Air Filter and close the Intake Grille.

- Align the sides of the Air Filter with the panel, and push in fully, making sure the two lower tabs are returned properly to their holes in the panel.

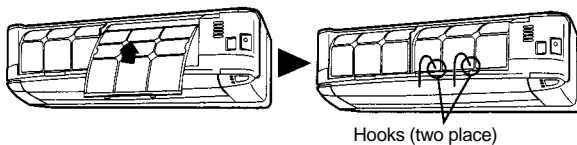

- Close the Intake Grille.

(For purposes of example, the illustration shows the unit without Intake Grille installed.)

- Dust can be cleaned from the Air Filter either with a vacuum cleaner, or by washing the filter in a solution of mild detergent and warm water. If you wash the filter, be sure to allow it to dry thoroughly in a shady place before reinstalling.
- If dirt is allowed to accumulate on the Air Filter, air flow will be reduced, lowering operating efficiency and increasing noise.
- During periods of normal use, the Air Filters should be cleaned every two weeks.

When using the optional Air Cleaning Filter

- Install the optional Air Cleaning Filter set (APS-03D) as instructed (Instruction Manual are furnished with the Air Cleaning Filter set).

- When used for extended periods, the unit may accumulate dirt inside, reducing its performance. We recommend that the unit be inspected regularly, in addition to your own cleaning and care. For more information, consult authorized service personnel.
- When cleaning the unit's body, do not use water hotter than 40°C, harsh abrasive cleansers, or volatile agents like benzene or thinner.
- Do not expose the unit body to liquid insecticides or hairsprays.
- When shutting down the unit for one month or more, first allow the fan mode to operate continuously for about one-half day to allow internal parts to dry thoroughly.

TROUBLESHOOTING

⚠ WARNING

In the event of a malfunction (burning smell, etc.), immediately stop operation, immediately stop operation, disconnect the Power Supply Plug, and consult authorized service personnel.

Merely turning off the unit's power switch will not completely disconnect the unit from the power source. Always be sure to disconnect the Power Supply Plug or turn off your circuit breaker to ensure that power is completely off.

Before requesting service, perform the following checks :

	Symptom	Problem	See Page
NORMAL FUNCTIONS	Doesn't operate immediately :	<ul style="list-style-type: none"> If the unit is stopped and then immediately started again, the compressor will not operate for about 3 minutes, in order to prevent fuse blowouts. Whenever the Power Supply Plug is disconnected and then reconnected to a power outlet, the protection circuit will operate for about 3 minutes, preventing unit operation during that period. 	_____
	Noise is heard :	<ul style="list-style-type: none"> During operation and immediately after stopping the unit, the sound of water flowing in the air conditioner's piping may be heard. Also, noise may be particularly noticeable for about 2 to 3 minutes after starting operation (sound of coolant flowing). During operation, a slight squeaking sound may be heard. This is the result of minute expansion and contraction of the front cover due to temperature changes. 	_____
		<ul style="list-style-type: none"> During Heating operation, a sizzling sound may be heard occasional. This sound is produced by the Automatic Defrosting operation. 	70
	Smells :	<ul style="list-style-type: none"> Some smell may be emitted from the indoor unit. This smell is the result of room smells (furniture, tobacco, etc.) which have been taken into the air conditioner. 	_____
	Mist or steam are emitted :	<ul style="list-style-type: none"> During Cooling or Dry operation, a thin mist may be seen emitted from the indoor unit. This results from the sudden Cooling of room air by the air emitted from the air conditioner, resulting in condensation and misting. 	_____
		<ul style="list-style-type: none"> During Heating operation, the outdoor unit's fan may stop, and steam may be seen rising from the unit. This is due to Automatic Defrosting operation. 	70
	Airflow is weak or stops :	<ul style="list-style-type: none"> When Heating operation is started, fan speed is temporarily very low, to allow internal parts to warm up. 	_____
		<ul style="list-style-type: none"> During Heating operation, the unit will temporarily stop operation (between 7 and 15 minutes) as the Automatic Defrosting mode operates. During Automatic Defrosting operation, the OPERATION indicator lamp will flash. 	70
		<ul style="list-style-type: none"> The fan may operate at very low speed during Dry operation or when the unit is monitoring the room's temperature. 	61
		<ul style="list-style-type: none"> During SUPER QUIET operation, the fan will operate at very low speed. 	61
		<ul style="list-style-type: none"> In the monitor AUTO operation, the fan will operate at very low speed. 	61
	Water is produced from the outdoor unit :	<ul style="list-style-type: none"> During Heating operation, water may be produced from the outdoor unit due to Automatic Defrosting operation. 	70
The outdoor unit does not stop even when heating operation is stopped :	<ul style="list-style-type: none"> When there is frost on the outdoor unit when heating operation is stopped, defrosting will be performed automatically. At this time, OPERATION Indicator Lamp will flash, and operation will stop after the outdoor unit has run for several minutes. 		

TROUBLESHOOTING

	Symptom	Problem	See Page
CHECK ONCE MORE	Doesn't operate at all :	<ul style="list-style-type: none"> Is the Power Supply Plug disconnected from its outlet? Has there been a power failure? Has a fuse blown out, or a circuit breaker been tripped? 	_____
		<ul style="list-style-type: none"> Is the POWER switch set to the OFF position? 	60
		<ul style="list-style-type: none"> Is the timer operating? 	63 – 64
	Poor Cooling (or Heating) performance :	<ul style="list-style-type: none"> Is the air filter dirty? Are the air conditioner's intake grille or outlet port blocked? Did you adjust the room temperature settings (thermostat) correctly? Is there a window or door open? In the case of Cooling operation, is a window allowing bright sunlight to enter? (Close the curtains.) In the case of Cooling operation, are there heating apparatus and computers inside the room, or are there too many people in the room? 	_____
<ul style="list-style-type: none"> Is the unit set for SUPER QUIET operation? 		61	
	The unit operates differently from the remote control unit's setting :	<ul style="list-style-type: none"> Are the Remote Control Unit's batteries dead? Are the Remote control Unit's batteries loaded properly? 	60

If the problem persists after performing these checks, or if you notice burning smells, or the TIMER Indicator Lamp (Fig. 3, ⑥) flashes, immediately stop operation, disconnect the Power Supply Plug (Fig. 1 ⑬) and consult authorized service personnel.

OPERATING TIPS

Cleaning the Air Filter

About the SLEEP Timer

- This air conditioner operates on the heat-pump principle, absorbing heat from outdoor air and transferring that heat indoors. As a result, the operating performance is reduced as outdoor air temperature drops. If you feel that insufficient heating performance is being produced, we recommend you use this air conditioner in conjunction with another kind of heating appliance.
- Heat-pump air conditioners heat your entire room by recirculating air throughout the room, with the result that some time may be required after first starting the air conditioner until the room is heated.

Microcomputer-controlled Automatic Defrosting

- When using the Heating mode under conditions of low outdoor air temperature and high humidity, frost may form on the outdoor unit, resulting in reduced operating performance. In order to prevent this kind of reduced performance, this unit is equipped with a Microcomputer-controlled Automatic Defrosting function. If frost forms, the air conditioner will

temporarily stop, and the defrosting circuit will operate briefly (for about 7 to 15 minutes).

During Automatic Defrosting operation, the OPERATION indicator lamp (red) will flash.

In Event of Power Interruption

Auto Restart

- The air conditioner power has been interrupted by a power failure. The air conditioner will then restart automatically in its previous mode when the power is restored.
- Operated by settings before the power failure. Then, the Air Flow Direction Louvers will automatically change to their standard direction.
- If a power failure occurs during TIMER operation, the timer will be reset and the unit will begin (or stop) operation at the new time setting. In the event that this kind of timer fault occurs, the TIMER Indicator Lamp (green) will flash (see page 59).
- Use of other electrical appliances (electric shaver, etc.) or nearby use of a wireless radio transmitter may cause the air conditioner to malfunction. In this event, temporarily disconnect the Power Supply Plug, reconnect it, and then use the Remote Control Unit to resume operation.

OPERATING TIPS

Temperature and Humidity Range

[°C]

DB : DRY Bulb Temperature WB : Wet Bulb Temperature	Cooling and Dry				Heating			
	Indoor		Outdoor		Indoor		Outdoor	
	DB	WB	DB	WB	DB	WB	DB	WB
Maximum Temperature	32	23	43	26	30	—	24	18
Minimum Temperature	18	13	10	—	2	—	-5	-6

- If the unit is used for long periods under high-humidity conditions, condensation may form on the surface of the indoor unit, and drip onto the floor or other objects underneath.
- If the air conditioner is used under higher temperature conditioner than those listed, the build-in protection circuit may operate to prevent internal circuit damage. Also, during Cooling and Dry modes, if the unit is used under conditions of lower temperature than those listed above, the heat-exchanger may freeze, leading to water leakage and other damage.
- Do not use this unit for any purpose other than the Cooling, Heating, and Dehumidifying, and air-circulation of rooms in ordinary dwellings.

SPECIFICATION

MODEL	INDOOR UNIT AST13PSA-W	OUTDOOR UNIT AOT13PNA
TYPE	HEAT&COOL MODEL (REVERSE CYCLE) INVERTER	
POWER	230V to 50Hz	
COOLING		
CAPACITY	3.7 (Minimum 1.03 to Maximum 4.0) kW	
INPUT POWER	1.48 (Minimum 0.35 to Maximum 1.82) kW	
CURRENT	6.5 (Maximum 8) A	
HEATING		
CAPACITY	4.85 (Minimum 0.8 to Maximum 6.1) kW	
INPUT POWER	1.61 (Minimum 0.33 to Maximum 2.28) kW	
CURRENT	7.1 (Maximum 10) A	
MAX. PRESSURE		
SUCTION	800kPa	
DISCHARGE	2700kPa	
REFRIGERANT	R22 950g	
DIMENSIONS & WEIGHT		
INDOOR UNIT		
Height/Width/Depth	280/815/179 mm	
Weight	9kg (NET)	
OUTDOOR UNIT		
Height/Width/Depth	535/695/250 mm	
Weight	34kg (NET)	

- The specifications listed in the above table were measured under the following conditions.
 - Temperatures

[°C]

	COOLING		HEATING	
	DB	WB	DB	WB
Indoor Temp.	27	19	20	15
Outdoor Temp.	35	24	7	6

- Position of the AIRFLOW DIRECTION flap
For ADJUSTING THE DIRECTION OF AIR CIRCULATION on Page 9, use position ② for COOLING and position ④ for HEATING.

