

FUJITSU

SPECIFICATIONS

INVERTER

**HEAT & COOL MODEL
(REVERSE CYCLE)**

**ROOM AIR CONDITIONER
CEILING WALL TYPE**

Indoor Unit

AWT14LSAZ

AWT17LSAZ

Outdoor Unit

AOT14LSAWC

AOT17LSAWC

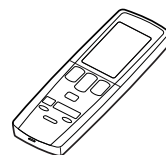
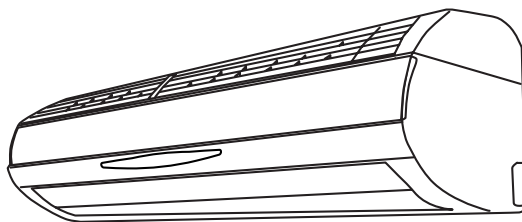

TYPE	HEAT & COOL MODEL (REVERSE CYCLE) INVERTER	
-------------	--	--

MODEL	INDOOR UNIT	AWT14LSAZ
	OUTDOOR UNIT	AOT14LSAWC

SPECIFICATIONS

POWER SUPPLY 240-(220) V-50 Hz	REFRIGERANT R410A 1350 g
COOLING	DIMENSIONS & WEIGHT
CAPACITY 4.0 kW (Minimum 0.9-Maximum 5.3 kW)	INDOOR UNIT
INPUT POWER 1.05 kW (Minimum 0.09-Maximum 1.75 kW)	Height/Width/Depth 250/890/288mm
CURRENT 4.5 A	Weight 13.5 kg (NET)
ENERGY EFFICIENCY RATIO 3.81	OUTDOOR UNIT
HEATING	Height/Width/Depth 578/790/300 mm
CAPACITY 6.0 kW (Minimum 0.9-Maximum 8.4 kW)	Weight 38 kg (NET)
INPUT POWER 1.39 kW (Minimum 0.09-Maximum 2.48 kW)	
CURRENT 5.9 A	

TYPE	HEAT & COOL MODEL (REVERSE CYCLE) INVERTER	
-------------	--	--

MODEL	INDOOR UNIT	AWT17LSAZ
	OUTDOOR UNIT	AOT17LSAWC

SPECIFICATIONS

POWER SUPPLY 240-(220) V-50 Hz	REFRIGERANT R410A 1350 g
COOLING	DIMENSIONS & WEIGHT
CAPACITY 4.8 kW (Minimum 0.9-Maximum 5.9 kW)	INDOOR UNIT
INPUT POWER 1.47 kW (Minimum 0.09-Maximum 1.9 kW)	Height/Width/Depth 250/890/288 mm
CURRENT 6.3 A	Weight 13.5 kg (NET)
ENERGY EFFICIENCY RATIO 3.27	OUTDOOR UNIT
HEATING	Height/Width/Depth 578/790/300 mm
CAPACITY 6.7 kW (Minimum 0.9-Maximum 8.5 kW)	Weight 38 kg (NET)
INPUT POWER 1.67 kW (Minimum 0.09-Maximum 2.66 kW)	
CURRENT 7.0 A	



Fig. 1

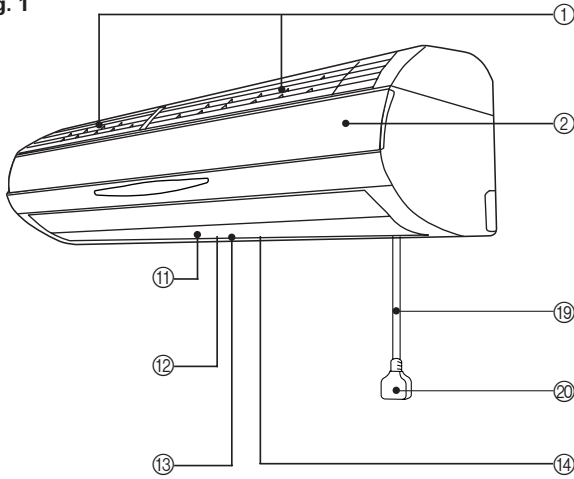

Fig. 2

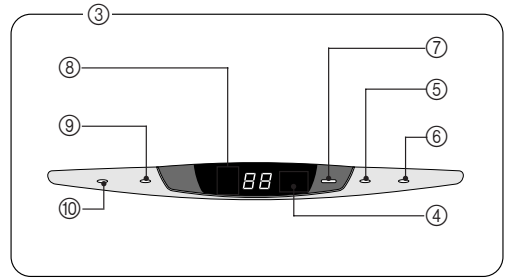

Fig. 3

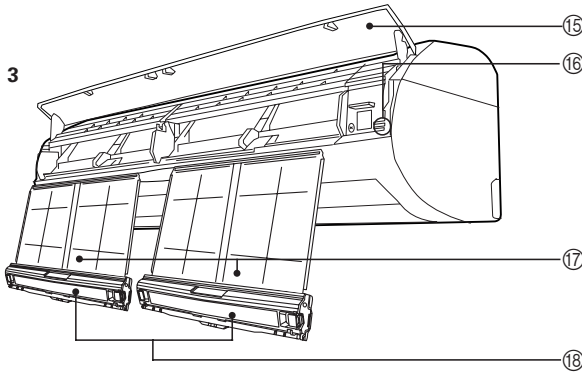

Fig. 4

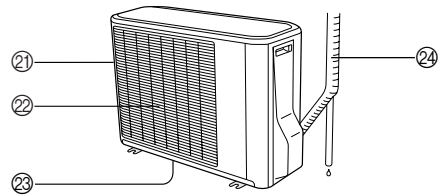

Fig. 5

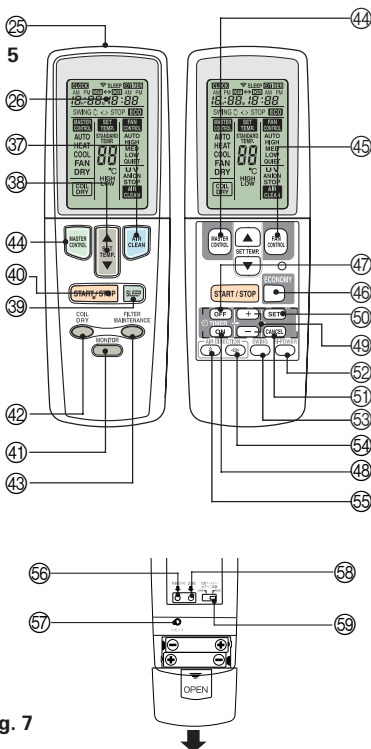

Fig. 6

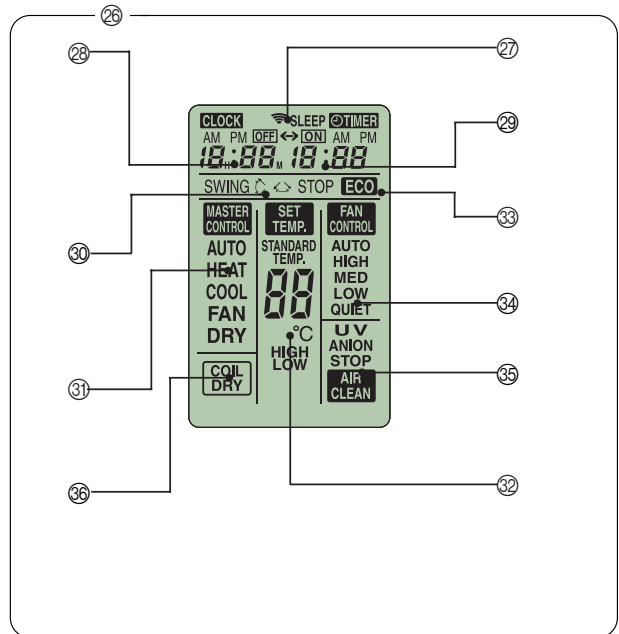
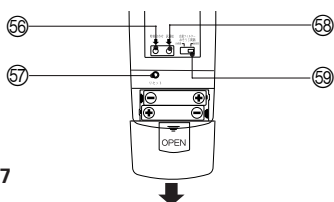

Fig. 7



This figure shows the control display when all indicator lamps are on. It may differ from the actual display.

CONTENTS

SAFETY PRECAUTIONS	En-1	UN AIR CLEANING/ANION OPERATION	En-13
FEATURES AND FUNCTIONS	En-2	COIL DRY OPERATION	En-14
NAME OF PARTS	En-3	MANUAL AUTO OPERATION	En-15
PREPARATION	En-4	TEMPERATURE MONITORING	En-16
OPERATION	En-6	AUTO FILTER MAINTENANCE	
TIMER OPERATION	En-8	FUNCTION	En-17
SLEEP TIMER OPERATION	En-9	PERFORMING MAINTENANCE	En-19
ADJUSTING THE DIRECTION OF		PERFORMING MAINTENANCE	
AIR CIRCULATION	En-10	(CONTINUED)	En-22
SWING OPERATION	En-11	ANION GENERATOR MAINTENANCE	EN-24
ECONOMY OPERATION	En-12	TROUBLESHOOTING	En-25
HI-POWER OPERATION	En-12	OPERATING TIPS	En-26

SAFETY PRECAUTIONS



DANGER!

- Do not attempt to install this air conditioner by yourself.
- This unit contains no user-serviceable parts. Always consult authorized service personnel for repairs.
- When moving, consult authorized service personnel for disconnection and installation of the unit.
- Do not become excessively chilled by staying for lengthy periods in the direct cooling airflow.
- Do not insert fingers or objects into the outlet port or intake grilles.
- Do not start and stop air conditioner operation by disconnecting the power supply cord and so on.
- Take care not to damage the power supply cord.
- In the event of a malfunction (burning smell, etc.), immediately stop operation, disconnect the power supply plug, and consult authorized service personnel.
- If the power supply cord of this appliance is damaged, it should only be replaced by the authorized service personal, since special purpose tools and specified cord are required.



CAUTION!

- Provide occasional ventilation during use.
- Do not direct air flow at fireplaces or heating apparatus.
- Do not climb on, or place objects on, the air conditioner.
- Do not hang objects from the indoor unit.
- Do not set flower vases or water containers on top of air conditioners.
- Do not expose the air conditioner directly to water.
- Do not operate the air conditioner with wet hands.
- Do not pull power supply cord.
- Turn off power source when not using the unit for extended periods.
- Check the condition of the installation stand for damage.
- Do not place animals or plants in the direct path of the air flow.
- Do not drink the water drained from the air conditioner.
- Do not use in applications involving the storage of foods, plants or animals, precision equipment, or art works.
- Connection valves become hot during Heating; handle with care.
- Do not apply any heavy pressure to radiator fins.
- Operate only with air filters installed.
- Do not block or cover the intake grille and outlet port.
- Ensure that any electronic equipment is at least one metre away from either the indoor or outdoor units.
- Avoid installing the air conditioner near a fireplace or other heating apparatus.
- When installing the indoor and outdoor unit, take precautions to prevent access to infants.
- Do not use inflammable gases near the air conditioner.

FEATURES AND FUNCTIONS

INVERTER

At the start of operation, a large power is used to bring the room quickly to the desired temperature. Afterwards, the unit automatically switches to a low power setting for economic and comfortable operation.

COIL DRY OPERATION

The Indoor unit can be dried by pressing the COIL DRY button on the Remote Control Unit so as to avoid going moldy and restrain the breed of bacterium.

AUTO CHANGEOVER

The operation mode (cooling, dry, heating) is switched automatically to maintain the set temperature, and the temperature is kept constant at all times.

WIRELESS REMOTE CONTROL UNIT

The Wireless Remote Control Unit allows convenient control of air conditioner operation.

HORIZONTAL AIRFLOW: COOLING/ DOWNWARD AIRFLOW: HEATING

For cooling, use horizontal airflow so the cool air does not blow directly on the occupants in the room. For heating, use downward airflow to send powerful, warm air to the floor and create a comfortable environment.

SWING OPERATION

The airflow-direction louvers move (swing) automatically. In addition, up, down, left, and right airflow directions can be selected using the Remote Control Unit.

MILDEW-RESISTANT FILTER

The AIR FILTER has been treated to resist mildew growth, thus allowing cleaner use and easier care.

SUPER QUIET OPERATION

When the FAN CONTROL button is used to select QUIET, the unit begins super-quiet operation; the indoor unit's airflow is reduced to produce quieter operation.

AUTO FILTER MAINTENANCE FUNCTION

The filter is automatically cleaned after a set amount of time of air conditioner operation.

UV AIR CLEANING/ANION OPERATION

The room air is disinfected with UV (ultraviolet rays).

INTERNAL UV CLEANING

Growth of mold and various germs inside the indoor unit is suppressed with UV (ultraviolet rays).

NAME OF PARTS

Fig. 1 Indoor Unit

- ① Intake Grilles
- ② Open Grille
- ③ Indicator (Fig. 2)
- ④ Remote Control Signal Receiver
- ⑤ OPERATION Indicator Lamp
- ⑥ TIMER Indicator Lamp
- ⑦ UV AIR CLEAN/ANION Indicator Lamp
- ⑧ OUTDOOR TEMP/ROOM TEMP. Indicator Lamp
- ⑨ HI-POWER OPERATION Indicator Lamp
- ⑩ MAINTENANCE Indicator Lamp
- ⑪ Air Flow Direction Louver
- ⑫ Right-Left Louver
(behind Air Flow Direction Louver)
- ⑬ Power Diffuser
- ⑭ Anion Generator
- ⑮ Open Panel (Fig. 3)
- ⑯ MAINTENANCE/MANUAL AUTO button
- ⑰ Air Filter
- ⑱ Dust Box
- ⑲ Power Supply Cord
- ⑳ Power Supply Plug

Fig. 4 Outdoor Unit

- ⑲ Intake Port
- ⑳ Outlet Port
- ㉑ Pipe Unit
- ㉒ Drain Port (bottom)

Fig. 5 Remote Control Unit

- ㉓ Signal Transmitter
- ㉔ Remote Control Unit Display (Fig. 6)
- ㉕ Transmit Indicator
- ㉖ Clock/OFF TIMER Display
- ㉗ ON TIMER Display
- ㉘ SWING Display
- ㉙ Operating Mode Display
- ㉚ Temperature Display
- ㉛ ECONOMY Operation
- ㉜ FAN CONTROL Display
- ㉝ AIR CLEAN Display
- ㉞ COIL DRY Display
- ㉟ AIR CLEAN button
- ㊱ SET TEMP. button (▲/▼)
- ㊲ SLEEP button
- ㊳ START/STOP button
- ㊴ MONITOR button
- ㊵ COIL DRY button
- ㊶ FILTER MAINTENANCE button
- ㊷ MASTER CONTROL button
- ㊸ FAN CONTROL button
- ㊹ ECONOMY Operation button
- ㊺ OFF TIMER button
- ㊻ ON TIMER button
- ㊼ SET TIME buttons (⊕/⊖)
- ㊽ SET (TIMER) button
- ㊾ CANCEL (TIMER) button
- ㊿ HI-POWER Operation button
- ① SWING button
- ② AIRFLOW DIRECTION (Left-Right) button
- ③ AIRFLOW DIRECTION (Up-Down) button
- ④ TIME ADJUST button (Fig. 7)
- ⑤ All Clear button
(Located inside battery compartment)
- ⑥ TEST RUN button
- ⑦ FILTER MAINTENANCE Interval Switch

PREPARATION

About the Remote Control Unit operation and display (dedicated display function)

- When a button is pressed on the Remote Control Unit, only indicators related to that operation appear on the Remote Control Unit display while unrelated indicators disappear (dedicated display function). This function allows easy confirmation of operation contents and is very convenient.
- To change the operation mode, temperature, or airflow, press the related button for the dedicated display function. Press the related button again to change the settings and transmit the signal to the Indoor Unit.

(Ex.) The MASTER CONTROL button is pressed during the auto mode.

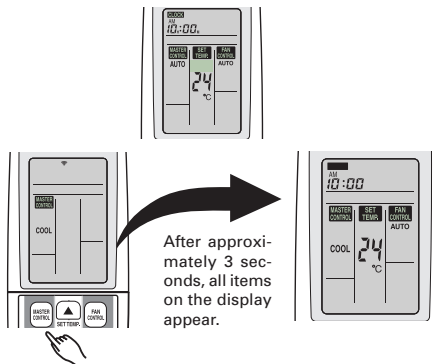

* Press the button twice to change to the cooling mode

About the TEST RUN button

- This button is used when installing the air conditioner and should not be used under normal conditions, as it will cause the air conditioner's thermostat function to operate incorrectly.
- If this button is pressed during normal operation, the unit will switch to the test operation mode and the OPERATION Indicator Lamp and TIMER Indicator Lamp on the Indoor Unit will flash simultaneously.
- To stop the test operation mode, press the START/STOP button to stop the air conditioner.

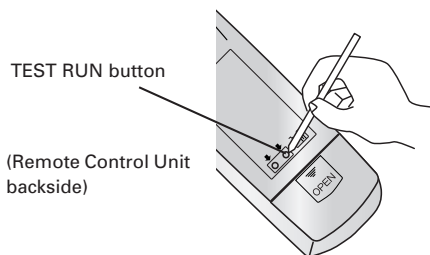

About the Compulsory Cooling Mode

- If the TEST RUN button is pressed during the cooling mode, the unit will change to the compulsory cooling mode and the room will be cooled regardless of the thermostat setting.
- Use the compulsory cooling mode to collect refrigerant in the outdoor unit before moving the air conditioner. (Do not use this button under normal conditions.)

Turn on the Power

Connect the Power Supply Plug (Fig. 1 ㉔) to an electrical outlet; in the case of a direct line connection, turn on the circuit breaker.

Load Batteries (LR03 × 2)

1 Press and slide the battery compartment lid on the reverse side to open it.

Slide in the direction of the arrow while pressing the  mark.

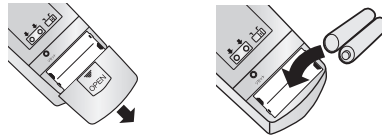

2 Insert batteries.

Be sure to align the battery polarities (+/−) correctly.

3 Close the battery compartment lid.

Set the Current Time

1 Press the SET (TIMER) button (Fig. 5 ㉔).

Use the tip of a ball-point pen or other small object to press the button.

2 Use the ⊕/⊖ SET TIME buttons (Fig. 5 ㉔) to adjust the clock to the current time.

⊕ button: Press to advance the time.

⊖ button: Press to reverse the time.

(Each time the buttons are pressed, the time will be advanced/reversed in one-minute steps. hold the buttons depressed to change the time quickly in ten-minute steps.)

3 Press the SET (TIMER) button (Fig. 5 ㉔).

This completes the time setting and starts the clock.

⚠ CAUTION!

- Take care to prevent infants from accidentally swallowing batteries.
- When not using the Remote Control Unit for an extended period, remove the batteries to avoid possible leakage and damage to the unit.
- If leaking battery fluid comes in contact with your skin, eyes, or mouth, immediately wash with copious amounts of water, and consult your physician.
- Dead batteries should be removed quickly and disposed of properly, either by placing in a public battery collection receptacle, or by returning to appropriate authority.
- Do not attempt to recharge dry batteries.

Never mix new and used batteries, or batteries of different types.

Batteries should last about one year under normal use. If the Remote Control Unit's operating range becomes appreciably reduced, replace the batteries and press the ACL button with the tip of a ballpoint pen or other small object.

To Use the Remote Control Unit

- The Remote Control Unit must be pointed at signal receiver (Fig. 2 ㉔) to operate correctly.
- Operating Range: About 7 meters.
- When a signal is properly received by the air conditioner, a beeping sound will be heard.
- If no beep is heard, press the Remote Control Unit button again.

Remote Control Unit Holder

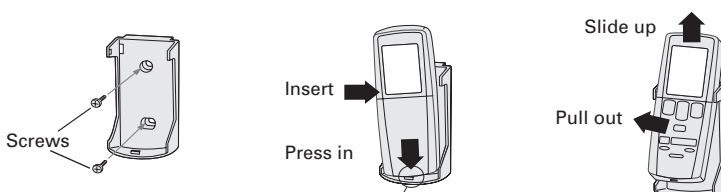

① Mount the Holder.

② Set the Remote Control Unit.

③ To remove the Remote Control Unit (when use hand).

OPERATION

To Select Mode Operation

- 1 Press the START/STOP button (Fig. 5 ④).**
The Indoor Unit's OPERATION Indicator Lamp (red) (Fig. 2 ⑤) will light. The air conditioner will start operating.
- 2 Press the MASTER CONTROL button (Fig. 6 ④) to select the desired mode.**
Each time the button is pressed, the mode will change in the following order.



About three seconds later, the entire display will reappear.

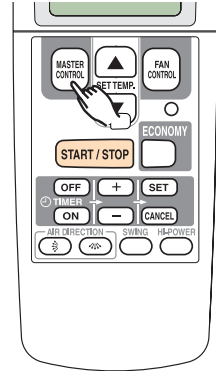

To Set the Thermostat

Press the SET TEMP. button (Fig. 5 ③).

- ▲ : Press to raise the thermostat setting.
- ▼ : Press to lower the thermostat setting.

●Thermostat setting range:

AUTO	18-30 °C
Heating	16-30 °C
Cooling/Dry	18-30 °C

The thermostat cannot be used to set room temperature during the FAN mode (the temperature will not appear on the Remote Control Unit's Display).

About three seconds later, the entire display will reappear.

The thermostat setting should be considered a standard value, and may differ somewhat from the actual room temperature.

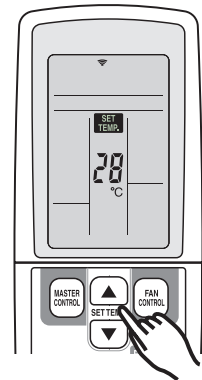

To Set the Fan Speed

Press the FAN CONTROL button (Fig. 5 ⑤).

Each time the button is pressed, the fan speed changes in the following order:



About three seconds later, the entire display will reappear.

When set to AUTO:

- Heating** : Fan operates so as to optimally circulate warmed air. However, the fan will operate at very low speed when the temperature of the air issued from the indoor unit is low.
- Cooling** : As the room temperature approaches that of the thermostat setting, the fan speed becomes slower.
- Fan** : The fan operates at the low speed.

The fan will operate at a very low setting during Monitor operation and at the start of the Heating mode.

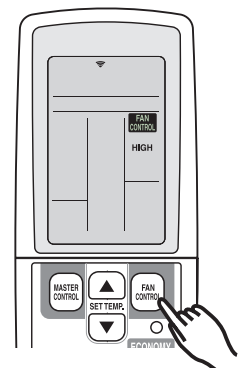

When set to QUIET:

SUPER QUIET operation begins. The Indoor Unit's airflow will be reduced for quieter operation.

- SUPER QUIET operation cannot be used during Dry mode. (The same is true when dry mode is selected during AUTO mode operation.)
- During Super Quiet operation, Heating and Cooling performance will be reduced somewhat.

To Stop Operation

Press the START/STOP button.

The OPERATION Indicator Lamp (red) (Fig. 2 ㉔) will go out.

About AUTO CHANGEOVER Operation

AUTO: ● When AUTO CHANGEOVER operation first selected, the fan will operate at very low speed for about one minute, during which time the unit detects the room conditions and selects the proper operating mode.

If the difference between thermostat setting and actual room temperature is more than +2 °C → Cooling or dry operation

If the difference between thermostat setting and actual room temperature is within ±2 °C → Monitor operation

If the difference between thermostat setting and actual room temperature is more than -2 °C → Heating operation

- When the air conditioner has adjusted your room's temperature to near the thermostat setting, it will begin monitor operation. In the monitor operation mode, the fan will operate at low speed. If the room temperature subsequently changes, the air conditioner will once again select the appropriate operation (Heating, Cooling) to adjust the temperature to the value set in the thermostat.

(The monitor operation range is ±2 °C relative to the thermostat setting.)

- If the mode automatically selected by the unit is not what you wish, select one of the mode operation (HEAT, COOL, DRY, FAN).

About Mode Operation

Heating: ● Use to warm your room.

- When Heating mode is selected, the air conditioner will operate at very low fan speed for about 3 to 5 minutes, after which it will switch to the selected fan setting. This period of time is provided to allow the indoor unit to warm up before begin full operation.

- When the room temperature is very low, frost may form on the outside unit, and its performance may be reduced. In order to remove such frost, the unit will automatically enter the defrost cycle from time to time. During Automatic Defrosting operation, the OPERATION Indicator Lamp (red) will flash, and the heat operation will be interrupted.

Cooling: ● Use to cool your room.

Dry: ● Use for gently cooling while dehumidifying your room.

- You cannot heat the room during Dry mode.
- During Dry mode, the unit will operate at low speed; in order to adjust room humidity, the Indoor Unit's fan may stop from time to time. Also, the fan may operate at very low speed when adjusting room humidity.
- The fan speed cannot be changed manually when Dry mode has been selected.

Fan: ● Use to circulate the air throughout your room.

During Heating mode:

Set the thermostat to a temperature setting that is higher than the current room temperature. The Heating mode will not operate if the thermostat is set lower than the actual room temperature.

During Cooling/Dry mode:

Set the thermostat to a temperature setting that is lower than the current room temperature. The Cooling and Dry modes will not operate if the thermostat is set higher than the actual room temperature (in Cooling mode, the fan alone will operate).

During Fan mode:

You can not use the unit to heat and cool your room.

TIMER OPERATION

Before using the timer function, be sure that the Remote Control Unit is set to the correct current time (See page 5).

To Use the OFF TIMER or ON TIMER

Open the Remote Control Unit lid to perform the timer function settings.

- 1 Press the START/STOP button (Fig. 5 ④)**
(if the unit is already operating, proceed to step 2).
The Indoor Unit's OPERATION Indicator Lamp (red) (Fig. 2 ⑤) will light.
- 2 Select the desired timer operation time, and then press the OFF TIMER button or the ON TIMER button.**
The OFF or ON timer indicator flashes.
- 3 Use the SET TIME buttons (Fig. 5 ④) to adjust the desired OFF time or ON time.**
 - ⊕ **Button:** Press to advance the time. The time advances in 5-minute increments.
 - ⊖ **Button:** Press to reverse the time. The time goes backward in 5-minute increments.
- 4 Point the Remote Control Unit towards the Indoor Unit and press the SET button.**
The OFF or ON timer Indicator stops flashing.
The TIMER Indicator Lamp (green) on the Indoor Unit will light.
If the ON TIMER function is selected, the air conditioner operation stops.

To Use the Program timer

- 1 Press the START/STOP button (Fig. 5 ④)**
(if the unit is already operating, proceed to step 2).
The Indoor Unit's OPERATION Indicator Lamp (red) (Fig. 2 ⑤) will light.
- 2 Set the desired times for OFF timer and ON timer.**
See the section "To Use the OFF timer or ON timer" to set the desired mode and times.
The indoor unit's TIMER Indicator Lamp (green) (Fig. 2 ⑥) will light.

About the Program timer

- The PROGRAM timer allows you to integrate OFF timer and ON timer operations in a single sequence. The sequence can involve one transition from OFF timer to ON timer, or from ON timer to OFF timer, within a twenty-four hour period.
- The first timer function to operate will be the one set nearest to the current time. The order of operation is indicated by the arrow in the Remote Control Unit's display (OFF → ON, or OFF ← ON).
- One example of PROGRAM timer use might be to have the air conditioner automatically stop (OFF timer) after you go to sleep, then start (ON timer) automatically in the morning before you arise.

To Cancel the Timer

Press the CANCEL button.

To Change the Timer Settings

Perform operations 2–4.

To Stop Air Conditioner Operation while the Timer is Operating

Press the START/STOP button.

To Cancel the Timer

Press the CANCEL button.

TIMER Indicator Lamp (green) will go out. Canceling the OFF TIMER or the ON TIMER

1. Press the TIMER button of the function to cancel (OFF or ON).
2. Press the CANCEL button.

To Change the Timer Settings

1. Press the TIMER button of the function to change (OFF or ON).
2. Set the timer using the "⊕" and "⊖" TIMER buttons.
3. Press the SET button.

To Stop Air Conditioner Operation while the Timer is Operating

Press the START/STOP button.

SLEEP TIMER OPERATION

Unlike other timer functions, the SLEEP timer is used to set the length of time until air conditioner operate is stopped.

To Use the SLEEP timer

While the air conditioner is operating or stopped, press the SLEEP button (Fig. 5 ㉓).

Each time the button is pressed, the time changes in the following order:

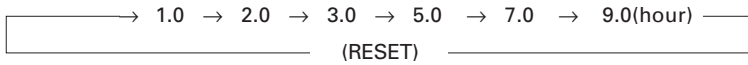

The Indoor Unit's OPERATION Indicator Lamp (red) (Fig. 2 ㉕) and the TIMER Indicator Lamp (green) (Fig. 2 ㉖) light.

To Change the Timer Settings

**Press the SLEEP button once to display the last setting time.
Press the SLEEP button again to change the time.**

Each time the button is pressed, the time changes in the following order (Change from the last setting time):

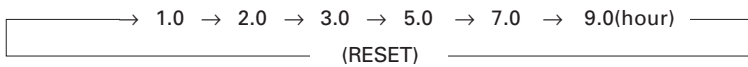

Confirmation of TIMER's time

The left time of the TIMER which is being set currently will be displayed for 5 seconds.

To Cancel the Timer:

Press the CANCEL (TIMER) button.

To Stop the Air Conditioner During Timer Operation:

Press the START/STOP button.

ADJUSTING THE DIRECTION OF AIR CIRCULATION

- Adjust the up, down, left, and right AIR directions with the AIR DIRECTION buttons on the Remote Control Unit.
- Use the AIR DIRECTION buttons after the Indoor Unit has started operating and the airflow-direction louvers have stopped moving.

Vertical Air Direction Adjustment

Open the lid on the Remote Control Unit.
Push the AIRFLOW DIRECTION (Up-Down) button.

- When the AIRFLOW DIRECTION (Up-Down) button is pushed, the airflow direction changes within the range to the right.
- You can select the desired airflow direction.

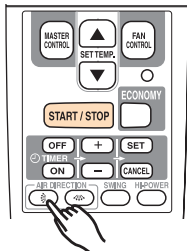

* The Remote Control Unit display does not change.

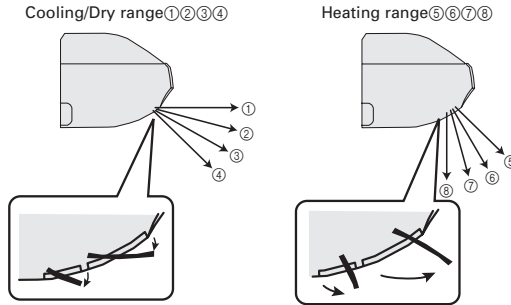

- * The up/down airflow-direction louvers move in the direction of the arrow from the closed position.
- In order to maximize the heating and cooling performance, use the ranges above.

Fan range ①②③④⑤⑥⑦⑧

⚠ DANGER!

- Never place fingers or foreign objects inside the outlet ports, since the internal fan operates at high speed and could cause personal injury.

About airflow direction adjustments

- When the unit is turned on or the operation mode is changed, the position of the airflow-direction louvers is automatically set as listed below to match the operation mode (heating, cooling, etc.) selected.
 Cooling/Dry/Fan: horizontal airflow
 Heating: downward airflow
- During HI-POWER operation (see page 12), the up/down airflow direction is set automatically to optimize the heating and cooling performance.
- When the AIR DIRECTION buttons on the Remote Control Unit are pressed, it may take a short time for the up/down airflow-direction louvers or the left/right airflow-direction louvers to reach the desired position. During that time, the airflow direction cannot be adjusted even if the AIR DIRECTION buttons are repeatedly pressed.
- During the monitor period in the auto mode (see page 7), horizontal airflow direction is set and cannot be adjusted.
- If the AIRFLOW DIRECTION (Up-Down) button is pressed during the up/down swing operation (see page 11), the up/down swing operation will stop. In addition, if the AIRFLOW DIRECTION (Left-Right) button is pressed during the left/right swing operation, the left/right swing operation will stop.

Right-Left Adjustment

Open the lid on the Remote Control Unit.
Push the AIRFLOW DIRECTION (Left-Right) button.

- When the AIRFLOW DIRECTION (Left-Right) button is pushed, the airflow direction will change in the following order.

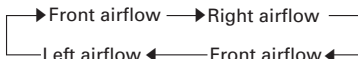

- You can select the desired airflow direction.
- The Indoor Unit is set for front airflow when the unit is turned on.

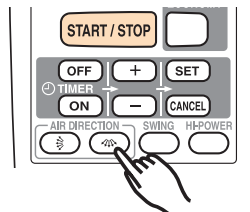

* The Remote Control Unit display does not change.

SWING OPERATION

Begin air conditioner operation before performing this procedure.

To select SWING Operation

Open the Remote Control Unit lid to perform swing operation settings.

Press the SWING button (Fig. 5 )

The SWING Display (Fig. 6 ) will light.

Each time the SWING button is pressed, the swing operation will change in the following order.

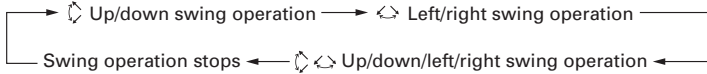

To stop SWING Operation

Press the SWING button and select STOP.

Airflow direction will return to the setting before swing was begun.

About Swing Operation

- Up/down swing: Swing operation begins using the following range according to the current airflow direction.
 - Airflow direction is 1–4 (for cooling, dry).
 - With the upper airflow-direction louver in the horizontal position, the lower airflow-direction louver moves (swings) to direct airflow to a wide area.
 - Airflow direction is 5–8 (for heating).
 - With the airflow-direction louvers set for downward or straight down airflow, airflow is directly mainly at the floor.
- Left/right swing: The airflow-direction louvers move (swing) in the left/right airflow direction.
- Up/down/left/right swing: The airflow-direction louvers move (swing) in both the up/down and left/right airflow directions.
- The SWING operation may stop temporarily when the air conditioner's fan is not operating, or when operating at very low speeds.
- If the AIRFLOW DIRECTION (Up-Down) button is pressed during the up/down swing operation, the up/down swing operation will stop and if the AIRFLOW DIRECTION (Left-Right) button is pressed during the left/right swing operation, the left/right swing operation will stop.

ECONOMY OPERATION

During Air Conditioner Operation

Open the Remote Control Unit lid, and then press the ECONOMY operation button.

"ECO" appears on the Remote Control Unit display.

- Economy operation begins.

Press the ECONOMY Operation button again

"ECO" disappears from the Remote Control Unit display.

- Normal operation begins.

About ECONOMY Operation

At the maximum output, ECONOMY Operation is approximately 70% of normal air conditioner operation for heating and cooling.

When ECONOMY operation is performed during the cooling mode, dehumidification is improved. This function is especially convenient when you want to remove the humidity in the room without significantly lowering the room temperature.

During ECONOMY operation, the thermostat setting automatically changes according to the outdoor temperature to avoid unnecessary heating and cooling for the most economical operation.

- If the room is not heated (or cooled) well during economy operation, select normal operation.
- Once air conditioner operation is stopped, normal operation begins when the indoor unit is turned on again.
- During the monitor period in the auto mode, the air conditioner operation will not change to ECONOMY operation even if ECONOMY operation is selected by pressing the ECONOMY operation button.

HI-POWER OPERATION

Begin air conditioner operation before performing this procedure.

To select HI-POWER Operation

- 1 Start air conditioner operation in auto, heating, cooling, or fan mode. The OPERATION Indicator Lamp (red) on the Indoor Unit (Fig. 2 ⑤) will light.**
- 2 Open the Remote Control Unit lid, and then press the HI-POWER button. The HI-POWER OPERATION Indicator Lamp (orange) on the Indoor Unit (Fig. 2 ⑨) will light.**

About HI-POWER Operation

- During heating mode
The Indoor Unit will operate at maximum power until the room temperature is 2°C above the thermostat setting.
- During cooling mode
The Indoor Unit will operate at maximum power until the room temperature is 1°C below the thermostat setting.
- During fan mode
The airflow from the Indoor Unit is increased.
- During dry mode
The airflow cannot be set during HI-POWER operation.

To stop HI-POWER Operation

Press the HI-POWER button again.

The HI-POWER OPERATION Indicator Lamp (orange) on the Indoor Unit will go out.

Normal operation begins.

However, HI-POWER Operation will automatically stop under the following conditions.

- During heating mode
The room temperature is 2°C above the thermostat setting.
- During cooling mode
The room temperature is 1°C below the thermostat setting or 30 minutes has passed since the HI-POWER operation began.
- During fan mode
15 minutes has passed since the HI-POWER operation began.

UV AIR CLEANING/ANION OPERATION

- The room air is disinfected with UV (ultraviolet rays).
- During UV air cleaning, anions, which are gentle on the body, spread throughout the room.

The settings can be changed after pressing the AIR CLEAN button on the Remote Control Unit two times.

To perform UV Air Cleaning during Air Conditioner Operation

Press the AIR CLEAN button during air conditioner operation.

The UV AIR CLEAN/ANION Indicator Lamp (blue) on the Indoor Unit will light.

To stop UV Air Cleaning only

Select STOP using the AIR CLEAN button.

The UV AIR CLEAN/ANION Indicator Lamp (blue) on the Indoor Unit will go out. AIR CLEAN disappears from the Remote Control Unit display. UV air cleaning stops but air conditioner operation continues.

To perform UV Air Cleaning only

Press the AIR CLEAN button while air conditioner operation is stopped.

The OPERATION Indicator Lamp (red) and the UV AIR CLEAN/ANION Indicator Lamp (blue) on the Indoor Unit will light.

UV air cleaning will begin. Press the START/STOP button to stop the UV air cleaning.

To stop All Operation

Press the START/STOP button.

About UV Air Cleaning

- During UV air cleaning, a small amount of ozone and odor may be produced.
- UV air cleaning cannot be used to remove carbon monoxide gas or alcohol fumes. Ventilate the room occasionally during UV air cleaning to avoid a lack of oxygen and possible suffocation.
- The airflow can be changed using the FAN CONTROL button.
UV air cleaning is most effective with the airflow at the maximum output.

About the Anion Generator

- The anion generator operates continuously during the UV air cleaning and produces anions.
- When the anion generator becomes dirty, a buzzing sound may be produced. If this occurs, perform anion generator maintenance.

COIL DRY OPERATION

- When the COIL DRY button on the Remote Control Unit is pressed, the inside of the Indoor Unit is dried, and then the UV (ultraviolet rays) lamp produces small amounts of ozone to suppress the growth of mold and various germs.
- After the COIL DRY button is pressed, COIL DRY operation is performed for approximately 30 minutes and then automatically stops.

To start COIL DRY Operation

Press the COIL DRY button (when the air conditioner is operating or stopped).

Only the OPERATION Indicator Lamp (red) on the Indoor Unit will light.

“COIL DRY” appears on the Remote Control Unit display and disappears after approximately 30 minutes.

If the COIL DRY button is pressed again during COIL DRY operation, COIL DRY operation will start again.

To stop COIL DRY Operation

Press the START/STOP button during COIL DRY operation.

The OPERATION Indicator Lamp (red) on the Indoor Unit will go out.

- The Remote Control Unit will be in the operation-stopped condition.

About COIL DRY Operation

The following procedures are performed during COIL DRY operation before the operation automatically stops after approximately 30 minutes.

- Drying (approximately 15 minutes)
After COIL DRY operation starts, the inside of the Indoor Unit is dried.
- Ozone (approximately 15 minutes)
The UV (ultraviolet rays) lamp produces small amounts of ozone to suppress the growth of mold and various germs.
- COIL DRY operation stops

⚠ NOTE!

- When COIL DRY operation begins, the Indoor Unit operates in the heating mode and the fan mode to dry the inside of the Indoor Unit. As a result, the room temperature and humidity may rise slightly.
- During COIL DRY operation, a small amount of ozone and odor may be produced.
- COIL DRY operation cannot be used to clean the air in the room.
- COIL DRY operation is most effective when performed frequently.

MANUAL AUTO OPERATION

Use the MANUAL AUTO operation in the event the Remote Control Unit is lost or otherwise unavailable.

REMOTE CONTROL UNIT UNAVAILABLE (MANUAL AUTO OPERATION)

If the Remote Control Unit is lost or the batteries are dead, the air conditioner can be operated provisionally from the indoor unit.

1. Open the open panel.

Grab both sides of the open panel and open the open panel until it is held in place. (The panel will remain open even after it is released.)

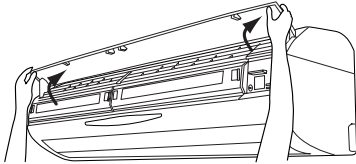

3. Close the open panel.

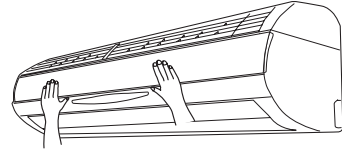

- Do not operate the air conditioner with the open panel open.

2. Press the MAINTENANCE/MANUAL AUTO button for 3 seconds.

- Press the MAINTENANCE/MANUAL AUTO button and continue to press the button even after a beeping sound is produced.

The OPERATION Indicator Lamp (red) on the Indoor Unit will light.

The air conditioner will operate in the auto mode (see page 7). Airflow will be automatic, airflow direction will be the standard setting, and the thermostat settings will be the standard temperature.

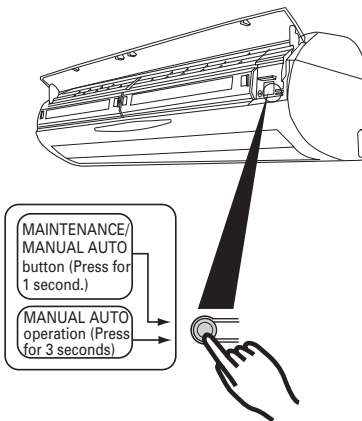

Stopping MANUAL AUTO Operation

Press the MAINTENANCE/MANUAL AUTO button for 3 seconds.

Air conditioner operation will stop and the OPERATION Indicator Lamp (red) on the Indoor Unit will go out.

TEMPERATURE MONITORING

- The room temperature and the outdoor temperature can be displayed. This information is helpful in selecting the appropriate operation mode and thermostat setting.
- Use this function after the air conditioner is operating.

To change the Temperature Monitoring

During air conditioner operation, press the MONITOR button.

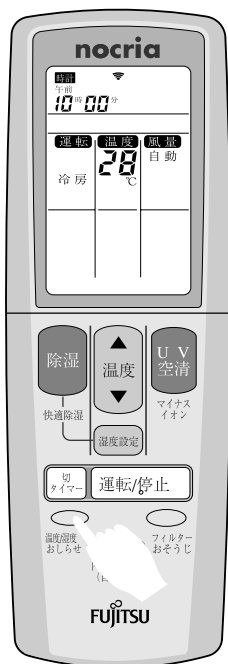

* The Remote Control Unit display does not change.

- Each time the MONITOR button is pressed, the display on the Indoor Unit changes in the following order.

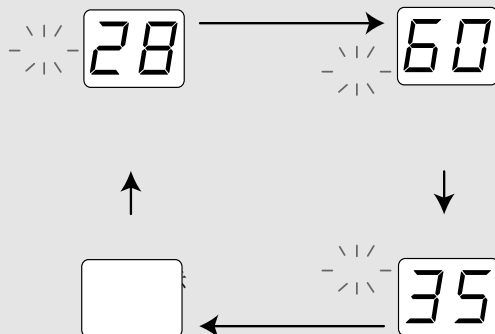

- When the power supply cord is plugged into the electrical outlet and the air conditioner operates for the first time, the room temperature is displayed. Use the MONITOR button to display the room temperature or outdoor temperature.
- If the outdoor temperature is selected, the room temperature will be displayed after 10 seconds. (The OUTDOOR TEMP. Indicator Lamp goes out.)
- To turn the temperature monitor display off, press the MONITOR button until there is no temperature displayed. For UV air cleaning (see page 13), the UV AIR CLEAN/ANION Indicator Lamp (blue) on the Indoor Unit will go out. This is useful at times when the display is too bright such as at bedtime.

About the Temperature Monitor

- The temperature displayed is the temperature of the Indoor Unit and Outdoor Unit intake air. Depending on the installation conditions of the Indoor Unit and Outdoor Unit, the actual temperature may be different. Use only as a reference.
- Approximately 1 hour after the start of heating or cooling, the temperature displayed will be higher than the thermostat setting on the remote control for heating and will be lower than the thermostat setting for cooling in order for the hi-power operation to start (see page 26).
- During air conditioner operation, the outdoor temperature displayed is affected by the exhaust and heat transfer from the outdoor unit. The displayed temperature will be higher than the actual temperature during cooling and drying and will be lower than the actual temperature during heating. (The difference between the actual and displayed temperature will be larger if the outdoor unit is installed in a narrow space.)
- Approximately 1 minute after air conditioner operation begins, the temperature is being detected and will not be displayed. During this time "--" is displayed.
- The displayed temperature range is -9°C-45°C. If the temperature is below -9°C, "-9" will be displayed and if the temperature exceeds 45°C, "45" will be displayed.
- If the ON TIMER is set (see page 8) and the air conditioner is stopped, the temperature will not be displayed on the Indoor Unit even if the MONITOR button is pushed. (The signal cannot be received.)
- Immediately after the automatic defrosting operation (see page 26), the air temperature around the Indoor Unit will be low and unstable and may cause the displayed room temperature to change.

AUTO FILTER MAINTENANCE FUNCTION

- This is a convenient function that automatically removes dust from the air filters after a set amount of time of air conditioner operation.
- The auto filter maintenance function can also be started using the remote control unit.

Auto Filter Maintenance

About operating the Auto Filter Maintenance

- Auto filter maintenance is performed after the air conditioner operates for a set amount of time and is stopped or the FILTER MAINTENANCE button on the Remote Control Unit is pressed.
- During auto filter maintenance, the MAINTENANCE Indicator Lamp (green) on the Indoor Unit will light.

1. Air filters come out

- The air filters automatically come out of the indoor unit under the open panel. At this time, the dust on the air filters is collected in the dust boxes (behind the open panel).

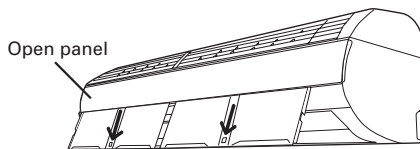

2. Air filters retract

- After the air filters come out, they automatically retract to their original positions in the Indoor Unit.

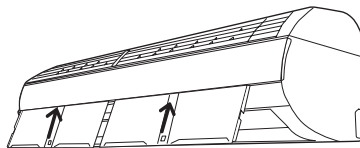

- When the auto filter maintenance is complete, the MAINTENANCE Indicator Lamp (green) on the Indoor Unit goes out.

Changing the FILTER MAINTENANCE Interval Switch

- Use the FILTER MAINTENANCE Interval Switch on the back of the Remote Control Unit to select the amount of time of air conditioner operation (150 hours or 200 hours) after which auto filter maintenance will be performed.

200 hours of operation

The air filters will be automatically cleaned after approximately 200 hours of air conditioner operation. This is the standard setting.

150 hours of operation

The air filters will be automatically cleaned after approximately 150 hours of air conditioner operation. Select this setting to clean the air filters more frequently.

About the Auto Filter Maintenance function

- Depending on how dirty the air filters are, all of the dust may not be removed from the air filters during the auto filter maintenance. In this case, perform auto filter maintenance again.
- If dust remains on the air filters after auto filter maintenance has been performed a number of times, perform dust box maintenance (see page 19).
- Depending on the condition of the dust on the air filters, such as if the dust is particularly oily or hardened, the dust may not be removed during the auto filter maintenance. In this case, remove the air filters and clean with water (see page 22).
- During auto filter maintenance, clicking or hissing sounds may be produced.

⚠ CAUTION!

Do not touch the air filters during the auto filter maintenance.

- The Indoor Unit may malfunction if the air filters are pulled or pushed.
- If the air filters are unnecessarily pulled, they may be damaged or fall and cause personal injury.

- If the air filters are pulled or pushed during the auto filter maintenance, the air filters will stop moving and the MAINTENANCE Indicator Lamp (green) will flash. If this occurs, follow procedures 1 and 4 in Dust box MAINTENANCE (see pages 19 and 21) to install the air filters.
- If the air filters are hanging out of the Indoor Unit after installation, they may automatically retract into the Indoor Unit.
- If furniture or obstacles are placed directly below the Indoor Unit, auto filter maintenance will not operate correctly if the air filters come out of the Indoor Unit and hit them.

Auto Filter Maintenance using the Remote Control Unit

Press the FILTER MAINTENANCE button (when the air conditioner is operating or stopped).

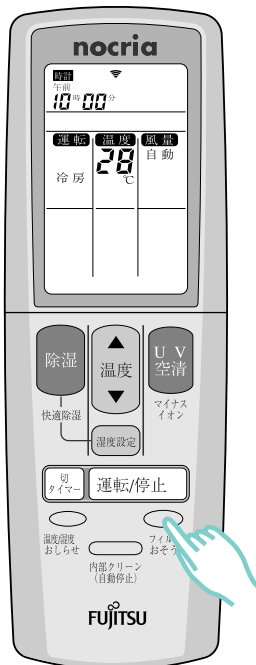

*The Remote Control Unit display does not change.

- The MAINTENANCE Indicator Lamp (green) on the Indoor Unit will light.
- Auto filter maintenance begins.
- If the FILTER MAINTENANCE button is pressed during air conditioner operation, the air conditioner will stop, auto filter maintenance will be performed, and the air conditioner will start operating again after the auto filter maintenance is complete.
- Even if the FILTER MAINTENANCE button is pressed during the auto filter maintenance, the cleaning will not stop.

About the MAINTENANCE Indicator Lamp

MAINTENANCE Indicator Lamp (green) lights

The MAINTENANCE Indicator Lamp (green) will light during auto filter maintenance.

MAINTENANCE Indicator Lamp (green) flashes (about once every 2 seconds)

The MAINTENANCE Indicator Lamp will flash during auto filter maintenance if the air filters are not installed or are pulled. If this occurs during air conditioner operation, unplug the power supply cord from the electrical outlet and follow procedures 1 and 4 in Dust Box Maintenance (see pages 19 and 21) to install the air filters.

MAINTENANCE Indicator Lamp (red) lights

The MAINTENANCE Indicator Lamp (red) will light if it is time to clean the dust boxes. If this occurs, clean the dust boxes (see page 19).

About the notification for Dust box cleaning

- The MAINTENANCE Indicator Lamp (red) on the Indoor Unit lights to notify that the dust boxes should be cleaned. If the lamp is lit, clean the dust boxes (see page 19).
- The MAINTENANCE Indicator Lamp (red) will light after approximately 2,000 hours of air conditioner operation.
- While the MAINTENANCE Indicator Lamp (red) is lit, auto filter maintenance will not be performed even if the FILTER MAINTENANCE button on the remote control unit is pressed. Clean the dust boxes, and then press the MAINTENANCE/MANUAL AUTO button (see page 21). (The MAINTENANCE indicator lamp (red) will go out.)
- The MAINTENANCE Indicator Lamp (red) will light if the air conditioner is operating or stopped.
- If the dust boxes are not cleaned and the MAINTENANCE Indicator Lamp (red) goes out, dust may fall from the indoor unit the next time auto filter maintenance is performed. If the MAINTENANCE Indicator Lamp (red) is lit, be sure to clean the dust boxes.

PERFORMING MAINTENANCE

- Frequent maintenance will extend the life of the air conditioner and improve the cooling and heating performance.
- Before maintenance, stop air conditioner operation using the remote control and unplug the power supply cord from the electrical outlet.

⚠ CAUTION!

<p>Before cleaning the air conditioner, be sure to turn it off and unplug the power supply cord from the electrical outlet.</p> <ul style="list-style-type: none"> ● The internal fan operates at high speed and could cause personal injury. 	<p>When cleaning the air conditioner, do not stand on any unstable objects.</p> <ul style="list-style-type: none"> ● You might fall and personal injury could result.
<p>When removing the dust boxes, do not touch any metal parts (heat exchanger, etc.).</p> <ul style="list-style-type: none"> ● Personal injury may result. 	<p>When cleaning the dust boxes, be sure to install them securely.</p> <ul style="list-style-type: none"> ● If the dust boxes are not properly installed, they could fall and cause personal injury.

Dust Box Maintenance

- If the MAINTENANCE Indicator Lamp (red) on the Indoor Unit is lit, be sure to clean the dust boxes. If the Indoor Unit is installed in an area with a lot of dust, clean the dust boxes every 3 months even if the MAINTENANCE Indicator Lamp (red) is not lit.
- When cleaning the dust boxes, dust may fall to the floor. Lay newspaper, etc. under the Indoor Unit before cleaning the dust boxes.

1. Remove the dust boxes and air filters from the indoor unit. Remove the air filters from the dust boxes.

- Preparation**
- Stop the air conditioner using the Remote Control Unit.
 - Unplug the power supply cord from the electrical outlet.

1. Open the open panel.

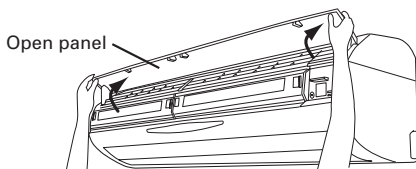

Grab both sides of the open panel and fully open the open panel. Continue to open the open panel past the horizontal position. (The panel will remain open even after it is released.)

3. Remove the dust boxes and air filters.

Grab the center of each dust box, lift the bottom in direction 1, and then remove the dust box in direction 2. (Remove the dust boxes and air filters together.)

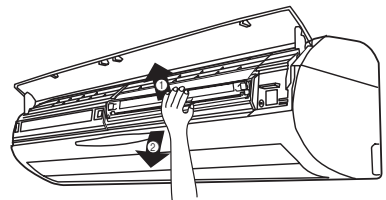

2. Open the latches on the dust boxes.

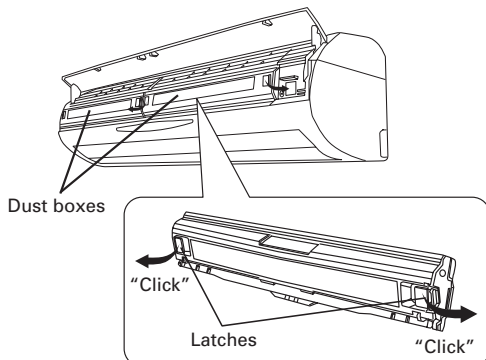

Open the two latches (yellow) on the ends of each dust box.

4. Remove the air filter from each dust box.

Grab the holding position on the air filter and pull the air filter out from the dust box in the direction of the arrow.

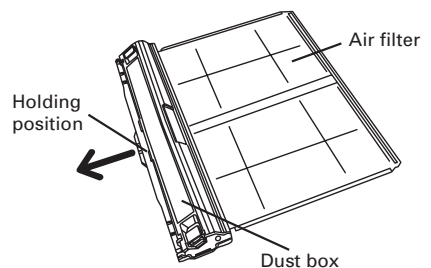

- When the air filter is removed from the dust box, dust may fall from the dust box. Lay newspaper, etc. under the dust box before removing the air filter.

2. Remove the dust collected in the dust boxes and clean the dust boxes.

1. Open the dust boxes.

- When opening each dust box, make sure the front case is facing down and the rear case is facing up. If the front case is facing up, a lot of dust will fall out of the dust box when it is opened.

- ① Make sure the rear case is on top and press the tab on the end of the case in the direction of the arrow (stamped on the case).

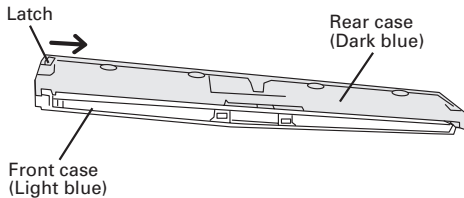

- ② While pressing the tab, lift up the side of the rear case with the tab. Remove the projection on the other side of the rear case from the hole in the front case and open the dust box.

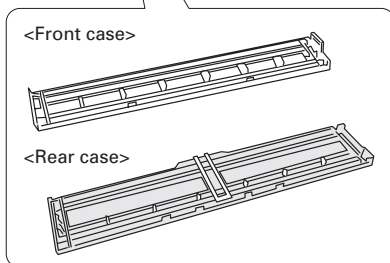
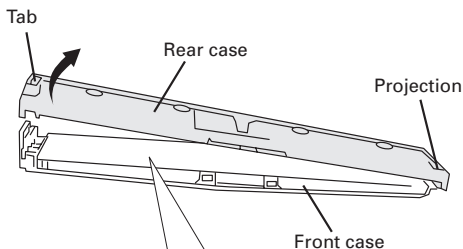

2. Open the brush holder on the front case and dispose of the dust.

< Front case (light blue)>

Open the brush holder and dispose of the collected dust.

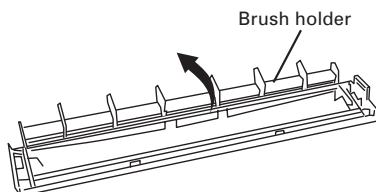

<Rear case (dark blue)>

Grab the tab on each brush holder on the rear case, open the brush holders, and then dispose of the collected dust.

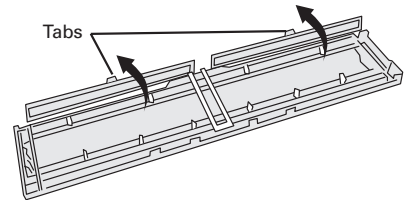

- Do not forcefully open the brush holders. The brush holders may be damaged and the Indoor Unit may malfunction.

3. Clean the inside of the front and rear cases.

Close the brush holders on the front and rear cases and remove the dust on the brushes with a vacuum cleaner or a toothbrush, etc.

< Front case >

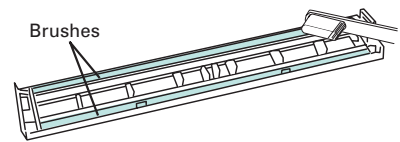

<Rear case >

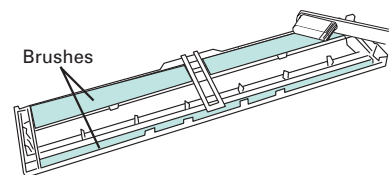

4. Wash the front and rear cases with water if they are extremely dirty.

- ① Lightly rub the brushes clean with 40°C–45°C hot water. If the brushes are difficult to clean, apply a mild synthetic laundry detergent (low or neutral alkalinity) and rub lightly.
- ② Rub the front and rear cases lightly with a sponge.
- ③ Rinse under running water.
- ④ Remove the water from the front and rear cases.
- ⑤ Wipe the brushes and cases with a towel, etc., and place in a shaded area to dry.

- Do not use a cleaner other than a mild synthetic laundry detergent (low or neutral alkalinity).
- Do not clean with hot water above 60°C.
- Do not clean with any abrasive or hard object.
- Do not dry with hot air from a hair dryer, etc. The cases may be deformed and the brushes may come off.
- After washing with water, make sure the dust boxes are completely dry before installation. The brushes are especially difficult to dry so wipe them with a towel, etc. to make sure they are completely dry. If the dust boxes are installed wet, the dust may not be removed from the air filters during auto filter maintenance.

3. Assemble the dust boxes, and install the air filters.

1. Assemble each dust box.

- Place the front casing facing down and insert the projection on the rear case into the hole in the front case.

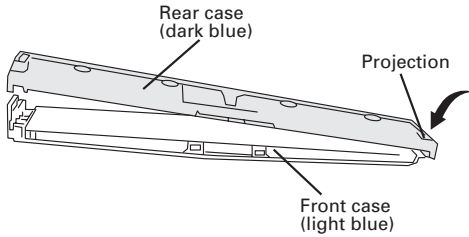

- When putting the front and rear cases together, make sure that the brush holders are not sticking out.
- Make sure the side of the rear case with the tab overlaps the front case and then install the rear case.

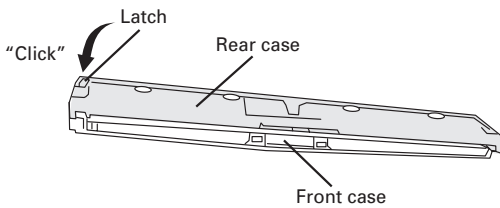

2. Install the air filters in the dust boxes.

- Align the insertion directions written on each dust box and air filter, and then insert the air filter into the dust box between the front and rear cases.

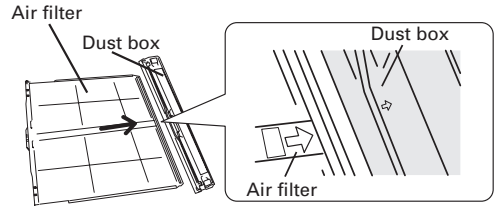

- When inserting the air filter, make sure it is not upside down or backwards, and then install correctly. If the air filter is not installed correctly, the indoor unit may malfunction.
- The air filter will be difficult to insert if you are pressing down on the dust box.
- Insert the air filter until it stops.

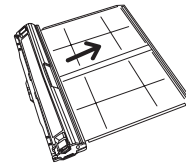

4. Install the dust boxes and air filters in the Indoor Unit, and then press the MAINTENANCE/MANUAL AUTO button.

1. Install the dust boxes and air filters in the indoor unit.

- When installing the dust boxes, make sure that the two latches (yellow) on the ends of each dust box are open. If the dust boxes are installed with the latches closed, the indoor unit may malfunction.
- Open the open panel, grab the holding position on each air filter, and then insert each filter into the indoor unit until it stops.

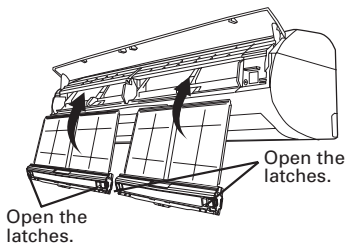

- Install the dust boxes and close the two latches (yellow) on the ends of each dust box.

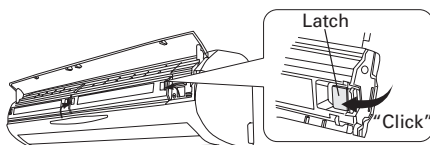

- If the air filters are hanging out of the indoor unit when the dust boxes and air filters are installed, remove the dust boxes and air filters and install them again.

2. Plug the power supply cord into the electrical outlet and press the MAINTENANCE/MANUAL AUTO button.

After installing the dust boxes, plug the power supply cord into the electrical outlet, and then press the MAINTENANCE/MANUAL AUTO button on the Indoor Unit for about 1 second.

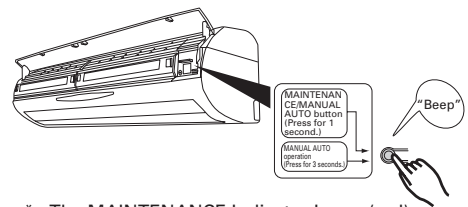

* The MAINTENANCE Indicator Lamp (red) will go out, if it is lit at this time.

- Press the MAINTENANCE/MANUAL AUTO button and release it after a beeping sound is produced. If the MAINTENANCE/MANUAL AUTO button is pressed for over 3 seconds, MANUAL AUTO operation will begin (see page 15).
- Be sure to press the MAINTENANCE/MANUAL AUTO button after completing MAINTENANCE. If the MAINTENANCE Indicator Lamp (red) remains on, auto filter maintenance will not be performed.

3. Close the open panel.

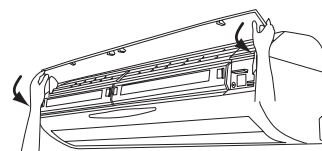

PERFORMING MAINTENANCE (CONTINUED)

Air Filter Maintenance

- Wash the air filters with water if small dust particles remain on the air filters even after auto filter maintenance is performed.
- It is recommended to perform dust box maintenance when the air filter maintenance is performed.

1. Open the open panel, and then remove the dust boxes and air filters.

Refer to procedure 1 in Dust Box Maintenance (page 19).

2. Remove the air filters from the dust boxes.

Refer to procedure 1 in Dust Box Maintenance (page 19).

3. Remove the dust with a vacuum cleaner, and then wash the air filters with water.

- Wipe the air filters with a towel, etc., after washing them with water, and then place them in a shaded area to dry.
- Do not bend the air filters. The air filters may be damaged and prevent the auto filter maintenance from being performed. Be especially careful not to damage the teeth of the rack on the back of each air filter.

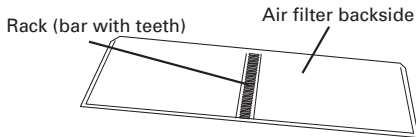

- Do not clean the air filters with any abrasive or hard object. The air filters may be damaged.
- Do not clean with hot water above 60°C.
- Do not dry with hot air from a hair dryer, etc. The air filters may be deformed.
- After washing the air filters with water, do not forcefully shake them dry. The air filters may be damaged.

4. Install the air filters in the dust boxes.

Refer to procedure 3 in Dust Box Maintenance (page 21).

5. Install the dust boxes and air filters in the indoor unit, and then close the open panel.

Refer to procedure 4 in Dust Box Maintenance (page 21).

- If auto filter maintenance is not performed normally after performing air filter maintenance (auto filter maintenance stops during filter cleaning or the air filters do not come out, etc.), remove the dust boxes and air filters and install them again.

Indoor Unit Maintenance

- Remove the dust from the exterior of the indoor unit with a vacuum cleaner, wipe the unit with lukewarm water, and then dry with a clean, soft cloth.
- Do not clean with water above 40°C. The exterior of the indoor unit may be deformed and become discolored.
- Do not clean with benzene, paint thinner, or polish. They will damage the exterior of the indoor unit.

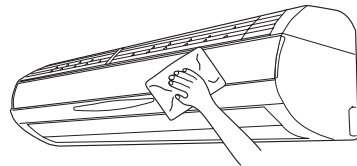

PERFORMING MAINTENANCE (CONTINUED)

Intake Grille Maintenance

- Perform dust box maintenance at the same time.

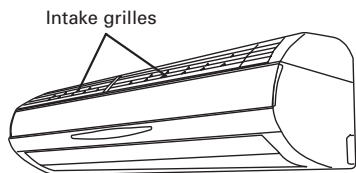

1. Open the open panel, and then remove the dust boxes and air filters.

Refer to procedure 1 in Dust Box Maintenance (page 19).

2. Lower the open panel to the horizontal position.

Lower the open panel to the horizontal position from the fully open position used when removing the dust boxes. (The panel will remain open even after it is released.)

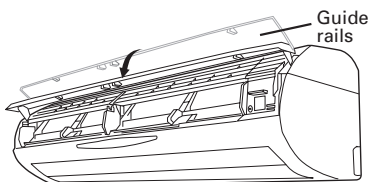

3. Remove the intake grilles.

- ① Grab the holding position on each intake grille and lift up. (The two projections on each grille will be released from the indoor unit.)

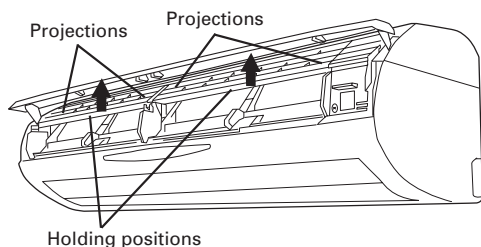

- ② Grab the holding position on each intake grille and pull the grill out from the indoor unit.

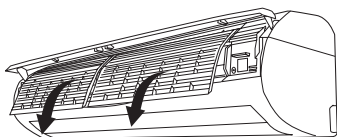

4. Wash with water.

Remove the dust from the intake grilles with a vacuum cleaner, wipe them with lukewarm water, and then dry them with a clean, soft cloth.



⚠ CAUTION!

- Be sure to install the intake grilles securely.
- If the intake grilles are not installed securely, they may fall and cause personal injury.

5. Install the intake grilles.

- ① Slide each intake grille into the indoor unit along the guide rails under the open panel until it stops. (Lift up slightly on the intake grille as it is being installed.)

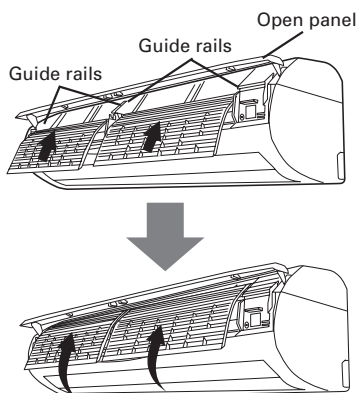

- Make sure that the intake grilles are installed in the correct direction. FRONT is stamped on the holding position of each intake grille.
- ② Insert the two projections on each intake grille into the indoor unit in the direction of the arrows shown.

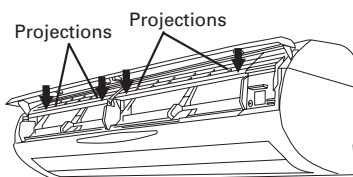

- If the intake grilles are not installed properly along the guide rails until they stop, the projections will not fit into the indoor unit. After installation, make sure the intake grilles are installed securely by gently moving them forward and backward and from side to side.

6. Install the dust boxes and air filters in the indoor unit, and then close the open panel.

Refer to procedure 4 in Dust Box Maintenance (page 21).

ANION GENERATOR MAINTENANCE

- Perform anion generator maintenance every 6 months.
- If anion generator produces hissing, buzzing, or crackling sounds, perform maintenance even if 6 months has not passed since the last maintenance.

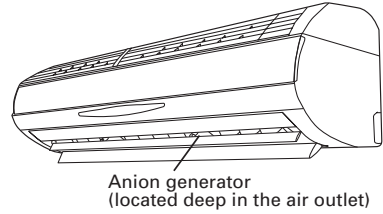

Preparation ● Stop the air conditioner using the remote control unit.

- Unplug the power supply cord from the electrical outlet.

- The anion generator is located deep inside the air outlet of the indoor unit. Be sure to stop the air conditioner operation and wait for the internal fan to stop completely before beginning the maintenance.
- Do not touch any metal part of the anion generator. Electric shock may result.

1. Manually open the lower up/down airflow-direction louver and power diffuser completely.

- The anion generator is installed deep inside the anion generator cover in the air outlet.

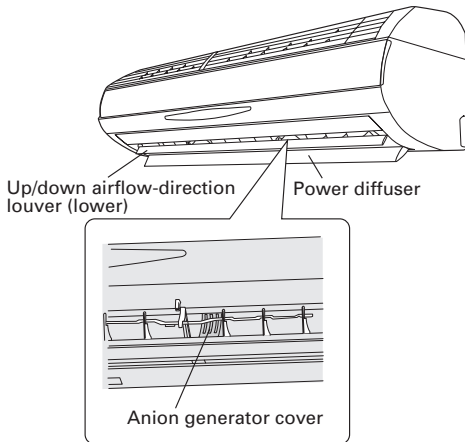

3. Manually close the lower up/down airflow-direction louver and power diffuser.

- After performing anion generator maintenance, the lower up/down airflow-direction louver and power diffuser may not close completely. If this occurs, plug the power supply cord into the electrical outlet and the lower up/down airflow-direction louver and power diffuser will return to their original positions.

2. Remove the dust from the anion generator cover.

- Gently remove the dust from the anion generator cover. Use a toothbrush, etc., and wipe the cover 3-4 times from the top to the bottom.
- Do not use a cotton swab or anything with a nap such as a cloth.

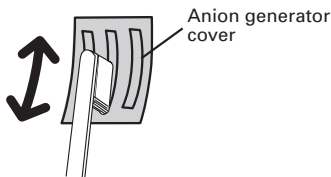

TROUBLESHOOTING

WARNING!

In the event of a malfunction (burning smell, etc.), immediately stop operation, disconnect the Power Supply Plug, and consult authorized service personnel.
Merely turning off the unit's power switch will not completely disconnect the unit from the power source. Always be sure to disconnect the Power Supply Plug or turn off your circuit breaker to ensure that power is completely off.

Before requesting service, perform the following checks:

	Symptom	Problem	See Page
NORMAL FUNCTION	Doesn't operate immediately:	<ul style="list-style-type: none"> ● If the unit is stopped and then immediately started again, the compressor will not operate for about 3 minutes, in order to prevent fuse blowouts. ● Whenever the Power Supply Plug is disconnected and then re-connected to a power outlet, the protection circuit will operate for about 3 minutes, preventing unit operation during that period. 	—
	Noise is heard:	<ul style="list-style-type: none"> ● During operation and immediately after stopping the unit, the sound of water flowing in the air conditioner's piping may be heard. Also, noise may be particularly noticeable for about 2 to 3 minutes after starting operation (sound of coolant flowing). ● During operation, a slight squeaking sound may be heard. This is the result of minute expansion and contraction of the front cover due to temperature changes. 	—
		<ul style="list-style-type: none"> ● During Heating operation, a sizzling sound may be heard occasional. This sound is produced by the Automatic Defrosting operation. 	26
	Smells:	<ul style="list-style-type: none"> ● Some smell may be emitted from the indoor unit. This smell is the result of room smells (furniture, tobacco, etc.) which have been taken into the air conditioner. 	—
	Mist or steam are emitted:	<ul style="list-style-type: none"> ● During Cooling or Dry operation, a thin mist may be seen emitted from the indoor unit. This results from the sudden Cooling of room air by the air emitted from the air conditioner, resulting in condensation and misting. 	—
		<ul style="list-style-type: none"> ● During Heating operation, the outdoor unit's fan may stop, and steam may be seen rising from the unit. This is due to Automatic Defrosting operation. 	26
	Airflow is weak or stops:	<ul style="list-style-type: none"> ● When Heating operation is started, fan speed is temporarily very low, to allow internal parts to warm up. ● During Heating operation, if the room temperature rises above the thermostat setting, the outdoor unit will stop, and the indoor unit will operate at very low fan speed. If you wish to warm the room further, set the thermostat for a higher setting. 	—
		<ul style="list-style-type: none"> ● During Heating operation, the unit will temporarily stop operation (between 7 and 15 minutes) as the Automatic Defrosting mode operates. During Automatic Defrosting operation, the OPERATION indicator lamp will flash. 	26
		<ul style="list-style-type: none"> ● The fan may operate at very low speed during Dry operation or when the unit is monitoring the room's temperature. 	6
		<ul style="list-style-type: none"> ● During SUPER QUIET operation, the fan will operate at very low speed. 	6
		<ul style="list-style-type: none"> ● In the monitor AUTO operation, the fan will operate at very low speed. 	6
	Water is produced from the outdoor unit:	<ul style="list-style-type: none"> ● During Heating operation, water may be produced from the outdoor unit due to Automatic Defrosting operation. 	26

TROUBLESHOOTING

	Symptom	Items to check	See Page
CHECK ONCE MORE	Doesn't operate at all:	<ul style="list-style-type: none"> ● Is the Power Supply Plug disconnected its outlet? ● Has there been a power failure? ● Has a fuse blown out, or a circuit breaker been tripped? 	—
		<ul style="list-style-type: none"> ● Is the timer operating? 	8 - 9
	Poor Cooling performance:	<ul style="list-style-type: none"> ● Is the Air Filter dirty? ● Air the air conditioner's intake grille or outlet port blocked? ● Did you adjust the room temperature settings (thermostat) correctly? ● Is there a window or door open? ● In the case of Cooling operation, is a window allowing bright sunlight to enter? (Close the curtains.) ● In the case of Cooling operation, are there heating apparatus and computers inside the room, or are there too many people in the room? 	—
		<ul style="list-style-type: none"> ● Is the unit set for SUPER QUIET operation? 	6
The unit operates differently from the Remote Control Unit's setting:	<ul style="list-style-type: none"> ● Are the Remote Control Unit's batteries dead? ● Are the Remote Control Unit's batteries loaded properly? 	5	

If the problem persists after performing these checks, or if you notice burning smells, or the TIMER indicator Lamp (Fig. 2 ㉔) flashes, immediately stop operation, disconnect the Power Supply Plug (Fig. 1 ㉔), and consult authorized service personnel.

OPERATING TIPS

Operation and Performance

Heating Performance

- This air conditioner operates on the heat-pump principle, absorbing heat from outdoor air and transferring that heat indoors. As a result, the operating performance is reduced as outdoor air temperature drops. If you feel that insufficient heating performance is being produced, we recommend you use this air conditioner in conjunction with another kind of heating appliance.
- Heat-pump air conditioners heat your entire room by recirculating air throughout the room, with the result that some time may be required after first starting the air conditioner until the room is heated.

Microcomputer-controlled Automatic Defrosting

- When using the Heating mode under conditions of low outdoor temperature and high humidity, frost may form on the outdoor unit, resulting in reduced operating performance.
In order to prevent this kind of reduced performance, this unit is equipped with a Microcomputer-controlled Automatic Defrosting function. If frost forms, the air conditioner will temporarily stop, and the defrosting circuit will operate briefly (for about 7-15 minutes).
During Automatic Defrosting operation, the OPERATION Indicator Lamp (red) will flash.

AUTO Restart

In Event of Power Interruption

- The air conditioner power has been interrupted by a power failure. The air conditioner will then restart automatically in its previous mode when the power is restored.
- Operated by setting before the power failure.
- If a power failure occurs during TIMER operation, the timer will be reset and the unit will begin (or stop) operation at the new time setting. In the event that this (kind of timer fault) occurs the TIMER Indicator Lamp will flash (see Page. 3).
- Use of other electrical appliances (electric shaver, etc.) or nearby use of a wireless radio transmitter may cause the air conditioner to malfunction. In this event, temporarily disconnect the Power Supply Plug, reconnect it, and then use the Remote Control Unit to resume operation.

OPERATING TIPS

Temperature and Humidity Range

	Cooling Mode	Dry Mode	Heating Mode
Outdoor temperature	About 21-43 °C	About 21-43 °C	About -10-24 °C
Indoor temperature	About 18-32 °C	About 18-32 °C	About 30 °C or less

- If the air conditioner is used under higher temperature conditions than those listed, the built-in protection circuit may operate to prevent internal circuit damage. Also, during Cooling and Dry modes, if the unit is used under conditions of lower temperature than those listed above, the heat-exchanger may freeze, leading to water leakage and other damage.
- Do not use this unit for any purposes other than the Cooling, Dehumidifying, and air-circulation of rooms in ordinary dwellings.
- If the unit is used for long periods under high-humidity conditions, condensation may form on the surface of the indoor unit, and drip onto the floor or other objects underneath. (About 80% or more)

