



## ROOM AIR CONDITIONER

# OPERATING MANUAL

## AF SERIES

Cool & Heat type  
(Reverse Cycle)

16 50 Hz MODEL

Supplied by

FUJITSU GENERAL (AUST.) PTY LIMITED

ACN 001229554

A Subsidiary of FUJITSU GENERAL LIMITED

HEAD OFFICE

SYDNEY : E&F Rydalmere Business Park,  
10-16 South Street, Rydalmere, N.S.W. 2116 TEL.[02]638 5199

MELBOURNE : 2nd Floor, 1-3 Wellington Street, Windsor, VIC. 3181  
(also all Tasmanian enquiries) TEL.[03]510 8652

BRISBANE : 5th Floor, 301 Coronation Drive Milton, QLD. 4064 TEL.[07]367 2008

ADELAIDE : 146 Fullarton Road, Rose Park, S.A. 5067 TEL.[08]364 0588

PERTH : Unit 6, 103 Erindale Road Balcatta W.A. 6021 TEL.[09]345 2011

 **CAUTION**

**R410A  
REFRIGERANT**

This Air Conditioner contains and operates  
with refrigerant R410A and Polyol Ester oil.

**THIS PRODUCT MUST ONLY BE INSTALLED OR SERVICED  
BY QUALIFIED PERSONNEL.**

Refer to Commonwealth, State, Territory and local legislation,  
regulations, codes, installation & operation manuals, before  
the installation, maintenance and/or service of this product.

**P/N 9353265029**

FUJITSU GENERAL LIMITED

# NAME OF PARTS AND OPERATION

## Before Starting

In order to enable efficient and trouble-free operation of your air conditioner, connect the power plug of your air conditioner through an exclusive

circuit, having a time delay fuse, to the correct power supply described on the rating plate. (240V, 50 Hz)

## ■ Control Panel

Hold the lower edge of the control panel cover and pull upward until it reaches its stopper.

Operation controls provided are THERMOSTAT, MASTER CONTROL, SUPER WAVE switch and EXHAUST AIR control.

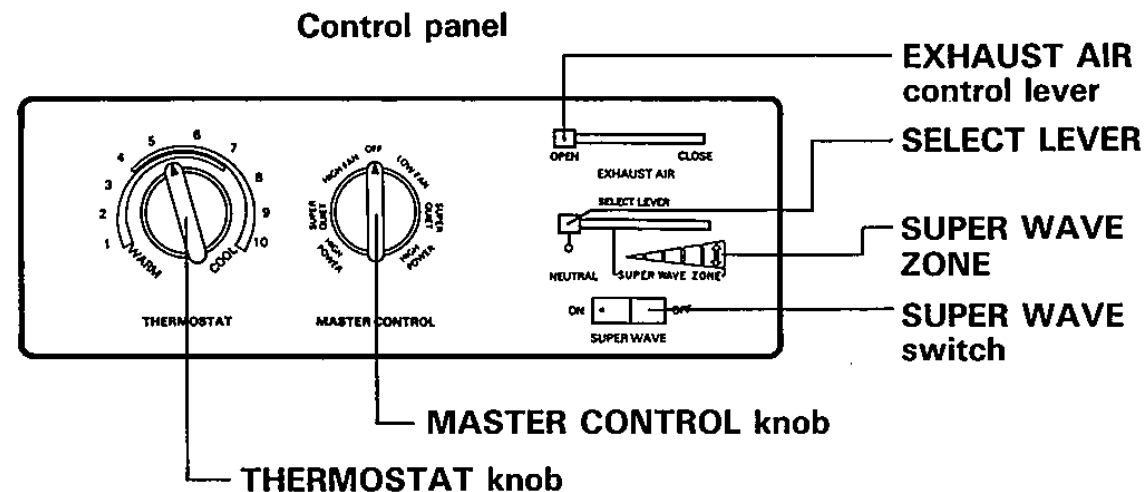
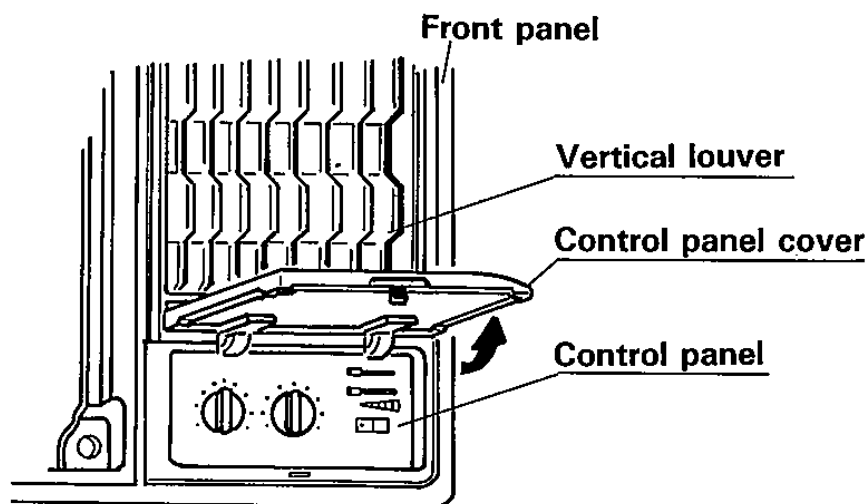

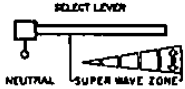
CONTROL	POSITION	FUNCTION
MASTER CONTROL	HIGH POWER (RED)	Fan (High Speed) and compressor operate — Rapid heating effect at top capacity.
	SUPER QUIET (RED)	Fan (Low Speed) and compressor operate — Intermediate heating effect and reduced operating noise.
	HIGH FAN	High fan speed without heating/cooling — Room air is circulated and cleaned.
	OFF	The air conditioner is switched off.
	LOW FAN	Low fan speed without heating/cooling — Room air is circulated and cleaned.
	SUPER QUIET (BLUE)	Fan (Low Speed) and compressor operate — Intermediate cooling effect and reduced operating noise.
	HIGH POWER (BLUE)	Fan (High Speed) and compressor operate — Rapid cooling effect at top capacity.
THERMOSTAT	WARM — COOL	Amount of heating/cooling is maintained automatically. Turn knob counterclockwise/clockwise to obtain most comfortable heating/cooling.
SUPER WAVE	ON	Vertical louvers continuously change the direction of air flow. When the MASTER CONTROL knob is set to "OFF", the SUPER WAVE does not operate.
	OFF	Vertical louvers stop enabling air flow to be directed in any desired direction.
SELECT LEVER		This lever is used to adjust the air flow direction and sweep angle. For details, refer to pages 6 ~ 9.
EXHAUST AIR	CLOSE	Exhaust vent is closed.
	OPEN	Room air is drawn outside.

## ■ Cooling

To obtain maximum cooling effect in the hot summer, select position HIGH POWER (BLUE) on the MASTER CONTROL. Maximum moisture removal, air circulation and dust removal are effected at the same time.

Selection of SUPER QUIET (BLUE) reduces operating noise.

## ■ Heating

To obtain maximum heating effect in severe winter select position HIGH POWER (RED) on the MASTER CONTROL. Maximum air circulation is obtained at the same time.

Selection of SUPER QUIET (RED) reduces heating effect and operating noise. However you may feel a higher temperature at the air outlet compared to the HIGH POWER (RED) position, due to the reduced fan speed.

### NOTE:

- After you start driving, it will take approximately 10 minutes for the air from this unit become warm. This delay is normal.
- If you find that insufficient room heat is produced, we recommend that you use the airconditioner together with other heating appliances.

## ■ Air Circulation

To maintain a comfortable room temperature, an important factor is the circulation of air. Room air can be circulated without cooling/heating by selecting either HIGH FAN or LOW FAN position on the MASTER CONTROL.

Circulation of air without cooling/heating can be also effected as follows:

1. When operating with the MASTER CONTROL switched to HIGH POWER (RED) or SUPER QUIET (RED), turn the thermostat fully clockwise.

2. When operating with the MASTER CONTROL switched to HIGH POWER (BLUE) or SUPER QUIET (BLUE), turn the thermostat fully counterclockwise.

## ■ Thermostat Control

Once the thermostat is set to the desired temperature, the room temperature will be automatically adjusted without excessive or insufficient cooling/heating and thus a comfortable environment is always maintained.

When cooling, turn the THERMOSTAT knob clockwise to increase cooling effect.

When heating, turn the THERMOSTAT knob counterclockwise to increase heating effect.

The thermostat controls the compressor only, and accordingly the fan is constantly circulating air even during the period when the compressor is off during cooling/heating operation. To stop the cooling/heating operation set the master control OFF position.

1. When you wish to lower the temperature, turn the THERMOSTAT knob clockwise in the direction of the higher numbers on the dial.
2. When you wish to increase the temperature, turn the THERMOSTAT knob counterclockwise in the direction of the lower numbers.
3. When the THERMOSTAT is set at positions "5", "6" or "7", comfortable room temperatures can usually be obtained. Please note that it is unhealthy for the room temperature to be lower than approximately 22°C.
4. When the THERMOSTAT is positioned at "10", the room-side fin coil may freeze up due to excessively low room temperature (for example, below 18°C) caused by

low outdoor temperature at night.

Once the fin coil becomes frozen, the air flow from the air conditioner is restricted by the frost, and the room temperature may rise due to the resultant weak cooling performance of the air conditioner.

5. The THERMOSTAT positions "8", "9" and "10" can be used when the room temperature does not become sufficiently low. This condition may occur when the thermostat switches off automatically because cooled air, when it passes through the horizontal louvers positioned downwards and the vertical louvers positioned to the left, makes a short circuit and the recirculated air touches the sensor of the thermostat.

**NOTE:** The thermostat controls the compressor only and accordingly the fan is constantly circulating air even during the period when the compressor is off.

### ■ Important

When cooling/heating is stopped by means of either the MASTER CONTROL or THERMOSTAT do not restart cooling/heating for at least three (3) minutes. If cooling/heating is restarted within this time, the compressor motor will be subjected to an over current and a compressor motor safety device will be actuated. If this occurs, restarting cooling/heating will not be possible for about 20 minutes.

### ■ Automatic Defrosting

When continuous heating is effected for a long period of time with low outside temperatures, the condenser tends

to frost up and heating efficiency will drop. To prevent this condition, the unit is equipped with an automatic defrosting system.

When frosting occurs the fan is stopped automatically. After 5 or so minutes the frost will have melted and the normal heating function is then automatically returned.

### ■ Exhaust Air Control

By setting EXHAUST AIR control lever to the appropriate positions between "OPEN" and "CLOSE" positions, it is possible to expel the room air to the desired extent. The quantity of air to be expelled will increase when the lever is positioned closer to the "OPEN" position.

**NOTE:** Cooling/heating effect will be reduced when operating EXHAUST open.

### ■ Air Direction Control

When the SUPER WAVE switch is turned to "ON" position, the vertical louver is automatically actuated and sweeps the jet of air alternately, right and left and thus more effective cooling/heating will be obtained.

Louvers may be stopped at any position when SUPER WAVE switch is turned off.

Sweep angle and direction can be adjusted with the select lever. The sweep can span an area either to the right or to the left. Select a sweep angle suitable to the layout of the room and the position of the air conditioner in the room which the air conditioner is installed.

## ■ Air Flow Adjustment

With this air conditioner, three air directions can be obtained as shown in the figures below. When the air flow direction is set, adjust to the desired sweep angle.

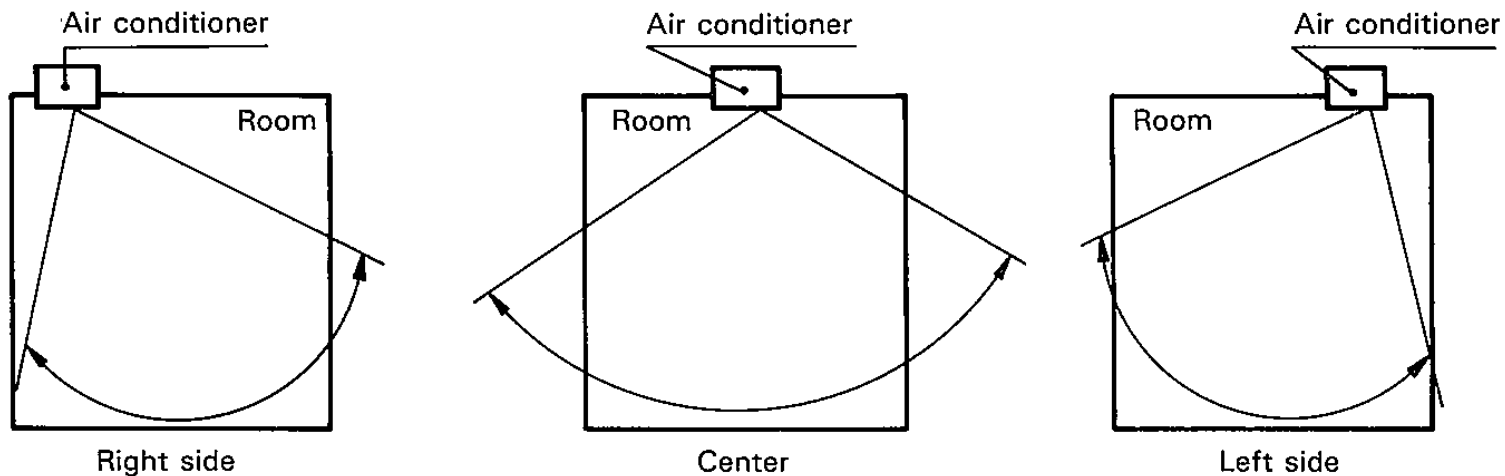

- NOTE:** Setting the vertical louver at high room humidity.
1. Set the SUPER WAVE switch to ON.
  2. Or, to use with the SUPER WAVE switch to OFF, set the switch to OFF when the vertical louver moves to the center.

## ■ Adjusting Sweep Angle

When the select lever is moved to the right or left, the sweep angle increases or decreases. Adjust the sweep angle within SUPER WAVE ZONE range.

**NOTE:** When the select lever is returned to the "NEUTRAL", the vertical louvers do not normal operate. If the select lever is returned to the "NEUTRAL" in error, readjust the sweep angle referring to "Adjusting Air Flow Direction and Sweep Angle".

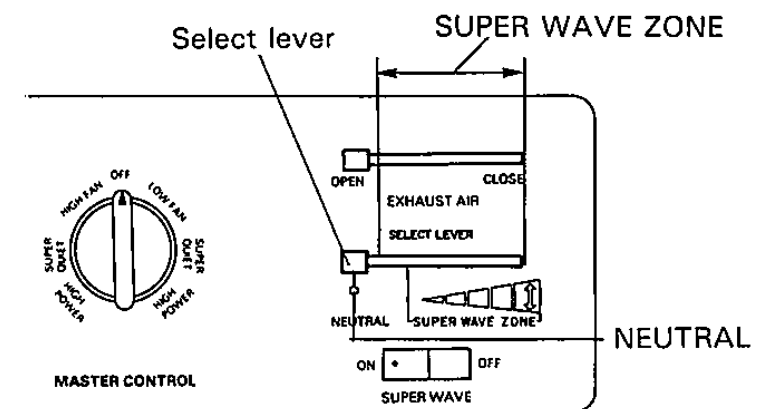

## ■ Adjusting Air Flow Direction and Sweep Angle

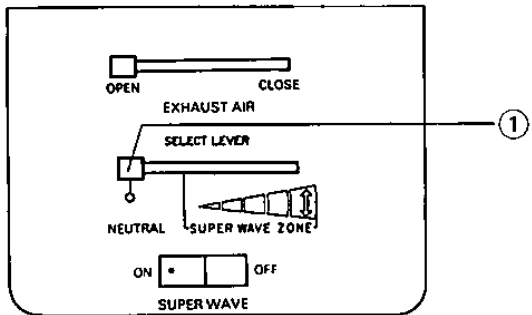
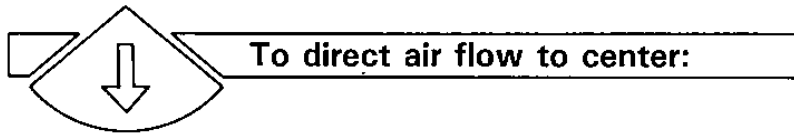

Vertical louver



Stop at the center

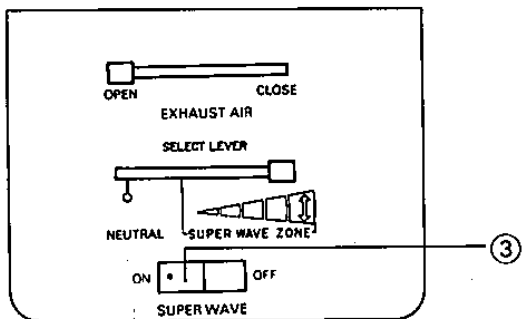
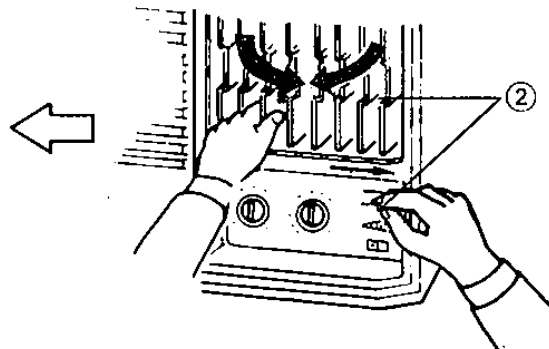

- ① Move the select lever fully left to the "NEUTRAL".
- ② Position the vertical louvers approx. at the center and move the select lever fully to the right end of the SUPER WAVE ZONE.
- ③ Set the SUPER WAVE switch to "ON".  
The vertical louvers start rotating with the maximum sweep angle.
- ④ The sweep angle can be adjusted within the SUPER WAVE ZONE range. When the select lever is returned to the left, the sweep angle decreases. Adjust sweep angle according to preference.

**NOTE:** If the MASTER CONTROL knob is set to "OFF", set it to the other position.

**NOTE:** If the select lever is returned to the "NEUTRAL" in error, the vertical louvers do not function properly. In this event, carry out the procedure from the beginning.

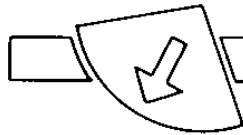

To direct air flow to left side:

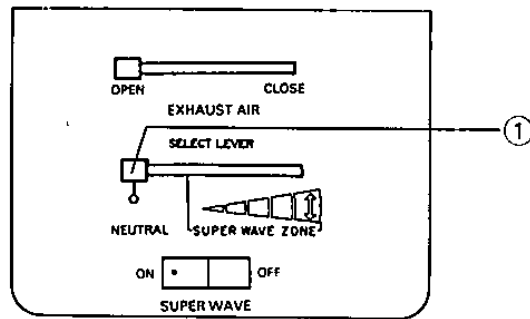

Vertical louver  
Move to the left

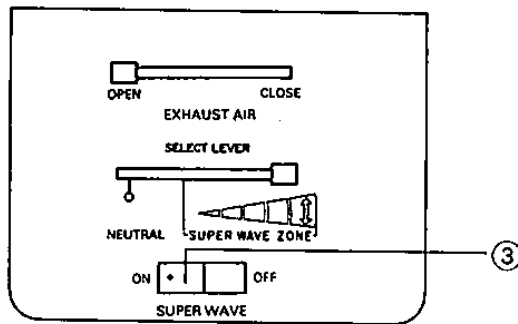
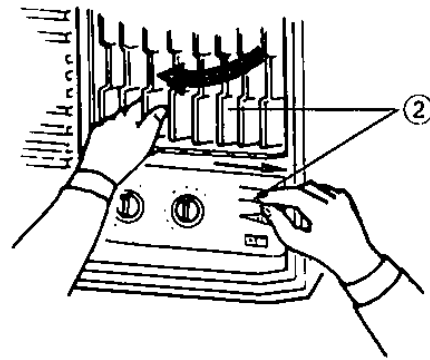

- ① Move the select lever fully left to the "NEUTRAL".
- ② Lightly move the vertical louvers to the left until they stop, and move the select lever fully to the right end of the SUPER WAVE ZONE.
- ③ Set the SUPER WAVE switch to "ON".  
The vertical louvers start rotating with the maximum sweep angle.
- ④ The sweep angle can be adjusted within the SUPER WAVE ZONE range. When the select lever is returned to the left, the sweep angle decreases. Adjust sweep angle according to preference.

**NOTE:** If the MASTER CONTROL knob is set to "OFF", set it to the other position.

**NOTE:** If the select lever is returned to the "NEUTRAL" in error, the vertical louvers do not function properly. In this event, carry out the procedure from the beginning.



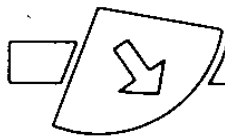

To direct air flow to right side:

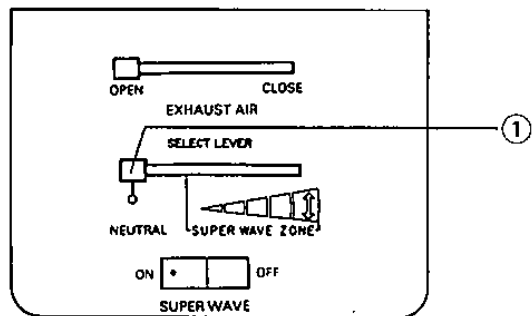

- ① Move the select lever fully left to the "NEUTRAL".
- ② Lightly move the vertical louvers to the right until they stop, and move the select lever fully to the right end of the SUPER WAVE ZONE.
- ③ Set the SUPER WAVE switch to "ON".  
The vertical louvers start rotating with the maximum sweep angle.

**NOTE:** If the MASTER CONTROL knob is set to "OFF", set it to the other position.

- ④ The sweep angle can be adjusted within the SUPER WAVE ZONE range. When the select lever is returned to the left, the sweep angle decreases. Adjust sweep angle according to preference.

**NOTE:** If the select lever is returned to the "NEUTRAL" in error, the vertical louvers do not function properly. In this event, carry out the procedure from the beginning.

Vertical louver  
Move to the right

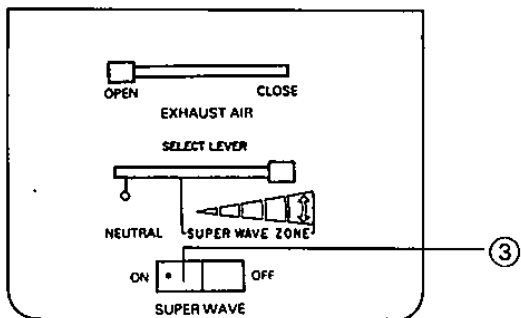
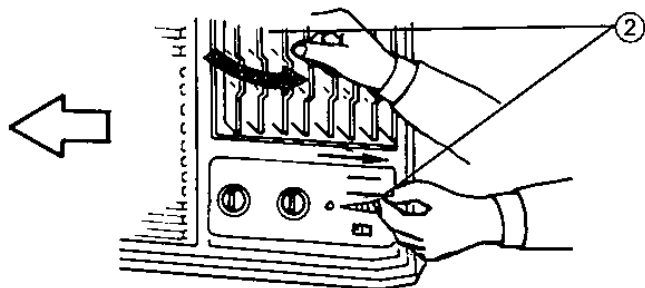

# MAINTENANCE

## ■ Room Air Filter

A filter is provided on the rear of the removable panel. Since the function of this filter is to filter dust and dirt in the air, please clean it regularly before it becomes clogged with dust. Wash the filter with clean water. If it is very dirty, rinse it in a synthetic detergent before washing in clean water. Allow the filter to dry thoroughly in the shade after washing. Remove the filter in the following manner.

Using the frip position, push the bottom of the removable panel up with your hand, pull it toward you, and the removable panel will be easily removed (See Fig. 1, Fig. 2).

The filter is attached to the rear side of the removable panel. Pull the lower edge of the filter forward in order to remove the filter from the removable panel (See Fig. 3). To replace the filter, insert the top edge of the filter under the hooks at the top of the removable panel, then press into the two lower hooks to fix into place (See Fig. 4).

When you want to refit the removable panel, insert it by pushing the upper edge of the removable panel against the upper part of the front panel.

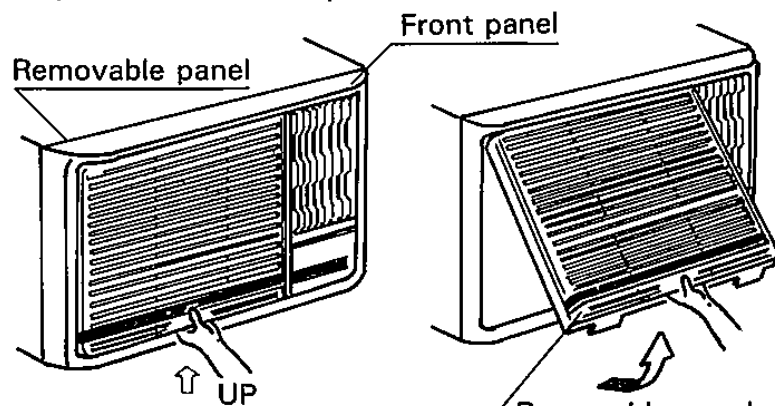

Fig. 1

Fig. 2

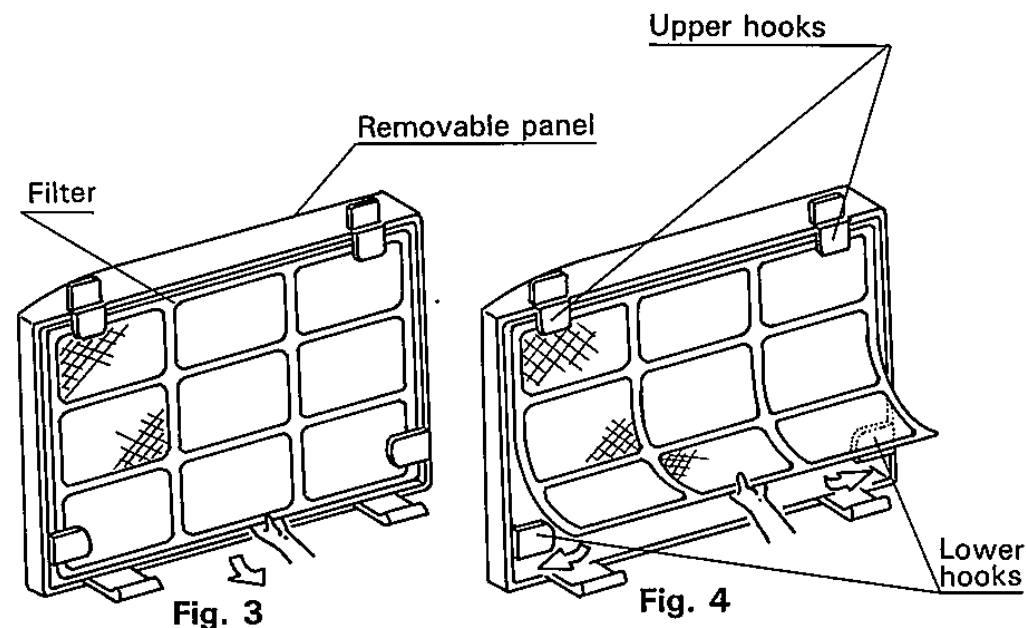

Fig. 3

Fig. 4

## ■ How to Remove the Front Panel

Remove the front panel in the following manner.

The front panel is attached to the cabinet with snap clips at the top and screws at the bottom. Remove the removable panel first and you will see two screws at the left and right of the bottom side. Take them off. (See Fig. 5) Hold up the front panel with your hands to remove it completely. (See Fig. 6) When refitting the front panel, insert the two clips on the upper part of the panel into the two slots at the top side of the cabinet. Press the front panel at its bottom side and fix it with screws. This completes refitting of the front panel.

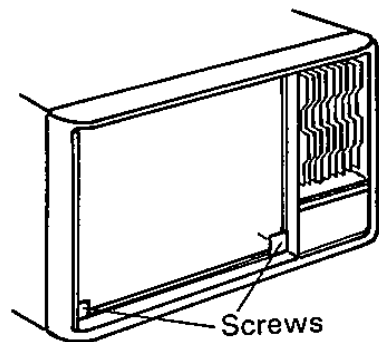

Fig. 5

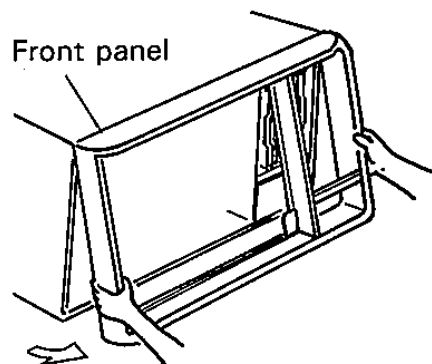

Fig. 6

**NOTE:**

1. A fuse may blow when a particularly large demand for electricity, which exceeds the capacity of the fuse, occurs in your home or when the voltage of the main power line drops due to some fault. If the fuse blows again after replacement with a new one, please call your dealer or service company.
2. Your air conditioner also acts to dehumidify the room air and to expel the water produced, therefore drops of water emitting from the outside of the unit is quite normal.
3. Please note, your room air conditioner will automatically control the room temperature within the thermostat range ..... 16°C (cooling) and 32°C (heating — reverse cycle type).
4. The noise level of your air conditioner may be felt to be higher at night than during the day. This is quite normal. This results from the fact that environmental noise level is lower at night so the noise level of the air conditioner is felt to be relatively higher.
5. When defrosting under heating operation, the curious sound which may be heard is quite normal.

■ **Things to Do Before Calling a Serviceman**

1. If your air conditioner does not operate, check the following items before calling for service.
  - a) Check that the power plug is properly connected to the power socket.
  - b) Check your fuses.
2. When cooling or heating effect is not obtained even with the air conditioner operating, make the following checks.
  - a) Check that the thermostat setting is higher than the room temperature when cooling.
  - b) Check that the thermostat setting is lower than the room temperature when heating.
  - c) Check the filter. A clogged filter will reduce cooling efficiency. When a filter is excessively dirty, cooling coils may ice up.
  - d) If the cooling coils are iced up, wash the filter. To get rid of the ice quickly, operate the air conditioner with the MASTER CONTROL knob on "FAN" position until all the ice has gone.

■ **General Information**

1. When the ambient temperature drops to 21°C (70°F) or less, icing-up may occur on the inside cooling coils, and is quite normal (when cooling).
2. The compressor motor does not require lubrication as it contains sufficient oil.
3. No lubrication is required for the bearings of the fan motor as dust shielded ball bearings containing grease are fitted.

**FUJITSU**

**FUJITSU GENERAL LIMITED**  
1116, Suenaga, Takatsu-ku, Kawasaki 213-8502, Japan