



OPERATING MANUAL
BEDIENUNGSANLEITUNG
MODE D'EMPLOI
MANUAL DE FUNCIONAMIENTO
MANUALE DI ISTRUZIONI
ΕΓΧΕΙΡΙΔΙΟ ΛΕΙΤΟΥΡΓΙΑΣ
MANUAL DE INSTRUÇÕES

OPERATING MANUAL

ROOM AIR CONDITIONER

WINDOW TYPE

COOLING MODEL

AKY7A

AKY9A

REVERSE

CYCLE MODEL

AKY9R

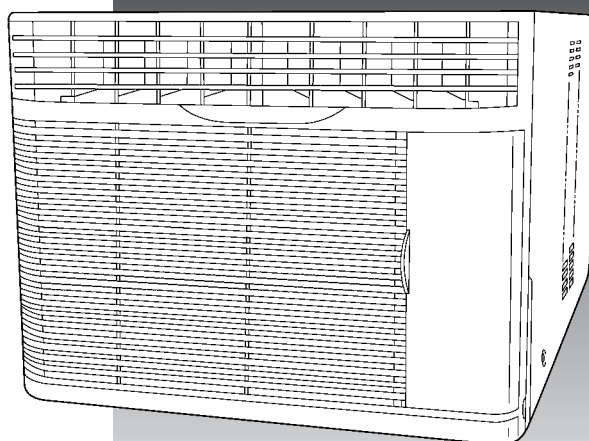

English

Deutsch

Français

Español

Italiano

Ελληνικά

Português

KEEP THIS OPERATION MANUAL
FOR FUTURE REFERENCE



FUJITSU GENERAL LIMITED

CONTENTS

PRECAUTIONS	2	CARE AND MAINTENANCE	11
NAME AND FUNCTION OF PARTS	6	TROUBLESHOOTING	12
AIR CONDITIONER OPERATION	7	OPERATION DETAILS	13
AIR DIRECTION ADJUSTMENT	10		

PRECAUTIONS

- Before using the appliance, read these "PRECAUTIONS" thoroughly and operate in the correct way.
- The instructions in this section all relate to safety; be sure to maintain safe operating conditions.
- "CAUTION" and "WARNING" have the following meanings in these instructions:





 WARNING!	This mark indicates procedures which, if improperly performed, might lead to the death or serious injury of the user.
 CAUTION!	This mark indicates procedures which, if improperly performed, might possibly result in personal harm to the user, or damage to property.

Safety Symbols

 △ The triangular symbol indicates WARNING and CAUTION items.

 ⊘ This symbol indicates prohibited operations. The prohibited action is indicated both within the symbol, and in nearby explanations.

 ● This symbol indicates instructions regarding operations which are to be performed by the user.

 DANGER	
Do not attempt to install this air conditioner by yourself.	
<ul style="list-style-type: none"> ● Consult authorized service personnel for all installations. 	
Consult authorized service personnel for any repairs.	
<ul style="list-style-type: none"> ● Do not attempt to remove parts, or service the unit yourself, since you may be exposed to dangerous electrical shock. This appliance contains no user-serviceable parts. 	
When moving, consult authorized service personnel for disconnection and installation of the unit.	

PRECAUTIONS



DANGER

Do not stay in direct cooling airflow for long periods.

- Excessive direct exposure to chilled air could be bad for your health.
- Be especially careful when going to bed, and in rooms where infants, aged, or sick people are staying.

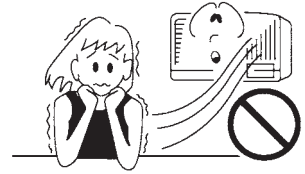

Do not insert fingers or objects into the outlet port or intake grilles.

- A fan operates at high speed inside the unit, and personal injury could result.
- Be particularly careful regarding small children.

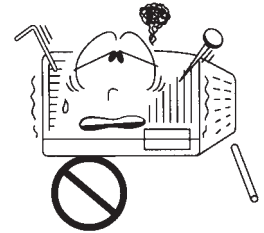

Do not start and stop air conditioner operation by disconnecting the power cord and so on.

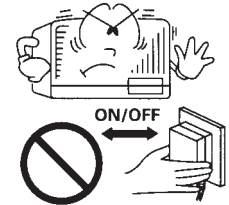

Take care not to damage the power cord.

- Do not stand heavy items on the power cord, or allow it to be pulled. Such treatment could damage the insulation, resulting in fire hazard and electrical shock.



WARNING

If the power supply cord of this air conditioner is damaged, it must be replaced by the manufacturer or its authorized service personnel only in order to avoid a safety hazard.

In the event of a malfunction (burning smell, etc.), immediately stop operation, disconnect the power plug, and consult authorized service personnel.

- Continuing to operate the unit under such conditions could lead to hazard of fire or electrical shock.



If the power supply cord of this appliance is damaged, it should only be replaced by the authorized service personnel, since special purpose tools and specified cord are required.



PRECAUTIONS



CAUTION

Provide occasional ventilation during use.

- Be careful to provide adequate ventilation particularly when using the unit in combination with other heating apparatus. (Heating)
- Insufficient ventilation could lead to oxygen starvation.

Do not direct air flow at fireplaces or heating apparatuses.

- Direct air blowing on fires could result in improper combustion or fire.

Do not drink the water drained from the air conditioner.

Do not set flower vases or water containers on top of air conditioners.

- Water leaking inside the unit could damage electrical insulation, leading to danger of electrical shock.

Do not expose the air conditioner directly to water.

- Electrical insulation could be damaged, resulting in electrical shock.

Do not operate the air conditioner with wet hands.

- Electrical shock could result.

Do not pull power cord.

- Pulling on the cord to disconnect the plug could damage the wires inside the cord, resulting in heat or fire.

Always turn off power and disconnect the power plug whenever cleaning the air conditioner or changing the air filter.

- A fan operates at high speed inside the unit, and personal injury could result.

Turn off power source when not using the unit for extended periods.

Check the condition of the installation for damage.

- After lengthy use, arrange for visit by authorized service personnel to check installation condition.

Do not use in applications involving the storage of foods, plants or animals, precision equipment, or art works.

- The quality of the stored items may deteriorate.

Do not place animals or plants in the direct path of the air flow.

- Lengthy exposure to direct Heating or Cooling airflow could have adverse influence on plants or animals.



CAUTION

Always operate with the air filter installed.

- Operating the unit without the air filter could cause excessive dirt to collect on internal parts, leading to malfunction.

Do not touch the heat exchanger radiator fins.

- Personal injury could result.
- Be particularly careful when cleaning.
- Bending or damage to the fins will affect the efficiency of the unit.

Do not block or cover the intake grille and outlet port.

- Obstructing the ports will reduce operating efficiency, leading to improper operation and possible damage.

When installing the air conditioner, take precautions to prevent access by infants.

- Unexpected accidents could occur.

Do not use inflammable gases near the air conditioner.

Avoid installing the air conditioner near a fireplace or other heating apparatus.

- Exposure to excessive heat could result in deformation of the outer case.

NAME AND FUNCTION OF PARTS

For details of operation, see the pages indicated by the  mark.

Air Conditioner Unit

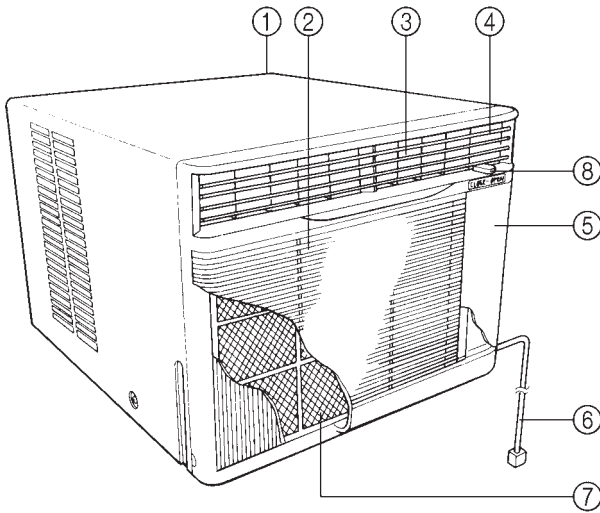

① Drain Tube

(At the bottom of the back side)

Moisture condensed from the air during Cooling is drained here.

② Air Intake Grille

Air is taken in here.

③ Right-Left Airflow-direction Louvres (P. 10)

Control airflow in the horizontal (right-left) direction.

④ Up-Down Airflow-direction Louvres (P. 10)

Control airflow in the vertical (up-down) direction.

⑤ Control Panel Cover

⑥ Power Supply Cord

⑦ Air Filter (P. 11)

Removes all dirt and dust from the air.

⑧ EXHAUST AIR Switch

CLOSE: Ventilation circulates through indoor air, without being carried out.

OPEN: Cigarette smoke and smell are exhausted to outside a room.

Note:

Cooling effect will be reduced when operating EXHAUST AIR "OPEN".

Control Panel

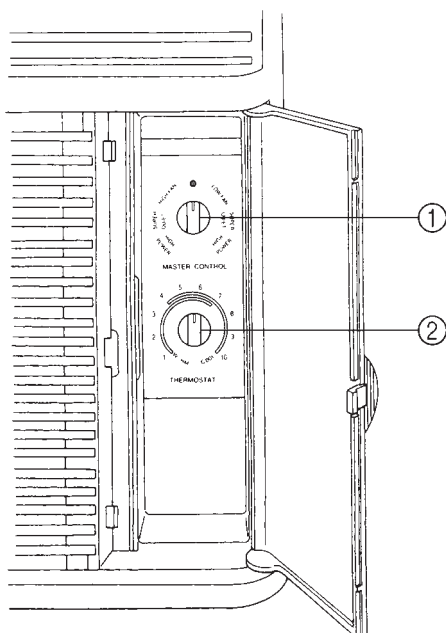

① MASTER CONTROL Switch (P. 7)

② THERMOSTAT Control Switch (P. 9)

AIR CONDITIONER OPERATION

COOLING MODEL

Power Supply

Connect the Power Supply Plug to an electrical point.

- Connect securely, without looseness.
- In the case of direct line connections, turn on the breaker.

MASTER CONTROL Switch

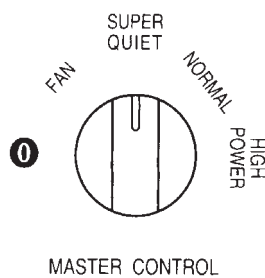

POSITION	FUNCTION
0 (OFF)	The air conditioner is switched off.
FAN	Fan only is operating to provide filtered air without cooling effect.
SUPER QUIET	Fan speed is low and cooling efficiency is intermediate with low noise level.
NORMAL	A cooling effect is obtained by a quieter operation than "HIGH POWER".
HIGH POWER	Fan speed is at its maximum resulting in maximum cooling effect.

Cooling

To obtain maximum cooling effect in the hot summer select position HIGH POWER on the master control. Maximum moisture removal, air circulation and dust removal are effected at the same time.

Selection of SUPER QUIET reduces operating noise.

Air Circulation

To maintain a comfortable room temperature an important factor is the circulation of air. Room air can be circulated without cooling by selecting FAN position on the master control.

Air circulation only without cooling effect may also be achieved with the thermostat knob turned counterclockwise to "1" position and with the master control knob at either "cool" position.

AIR CONDITIONER OPERATION

REVERSE CYCLE MODEL

Power Supply

Connect the Power Supply Plug to an electrical point.

- Connect securely, without looseness.
- In the case of direct line connections, turn on the breaker.

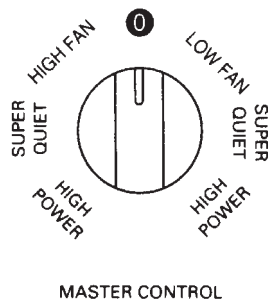

MASTER CONTROL Switch

POSITION	FUNCTION
HIGH POWER (RED)	Fan (High Speed) and compressor operate - Rapid heating effect at top capacity.
SUPER QUIET (RED)	Fan (Low Speed) and compressor operate - Intermediate heating effect and reduced operating noise.
HIGH FAN	High fan speed without heating/cooling - Room air is circulated and cleaned.
0 (OFF)	The air conditioner is switched off.
LOW FAN	Low fan speed without heating/cooling - Room air is circulated and cleaned.
SUPER QUIET (BLUE)	Fan (Low Speed) and compressor operate - Intermediate cooling effect and reduced operating noise.
HIGH POWER (BLUE)	Fan (High Speed) and compressor operate-Rapid cooling effect at top capacity.

Cooling

To obtain maximum cooling effect in the hot summer select position HIGH POWER (BLUE) on the MASTER CONTROL. Maximum moisture removal, air circulation and dust removal are effected at the same time.

Selection of SUPER QUIET (BLUE) reduces operating noise.

Heating

To obtain maximum heating effect in severe winter select position HIGH POWER (RED) on the MASTER CONTROL. Maximum air circulation is obtained at the same time.

Selection of SUPER QUIET (RED) reduces heating effect and operating noise. However you may feel a higher temperature at the air outlet compared to the HIGH POWER (RED) position, due to the reduced fan speed.

NOTE: After you start driving, it will take approximately 10 minutes for the air from this unit become warm. This delay is normal.

Air Circulation

To maintain a comfortable room temperature, an important factor is the circulation of air. Room air can be circulated without cooling/heating by selecting either HIGH FAN or LOW FAN position on the master control.

Circulation of air without cooling/heating can be also effected as follows:

1. When operating with the MASTER CONTROL switched to HIGH POWER (RED) or SUPER QUIET (RED), turn the thermostat fully clockwise.
2. When operating with the MASTER CONTROL switched to HIGH POWER (BLUE) or SUPER QUIET (BLUE), turn the thermostat fully counterclockwise.

COOLING MODEL

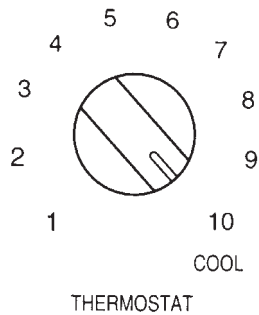

THERMOSTAT Control Switch

Once the THERMOSTAT is set to the desired temperature, the room temperature will be automatically adjusted without excessive or insufficient cooling/heating and thus a comfortable environment is always maintained.

The thermostat controls the compressor only, and accordingly the fan is constantly circulating air even during the period when the compressor is off during cooling/heating operation.

1. When you wish to lower the temperature, turn the THERMOSTAT Control switch clockwise in the direction of the higher numbers of the dial.
2. When you wish to increase the temperature, turn the THERMOSTAT Control switch counterclockwise in the direction of the lower numbers.

NOTE:

- When the THERMOSTAT Control switch is set at positions "5", "6" or "7" comfortable room temperatures can usually be obtained. Please note that it is unhealthy for the room temperature to be lower than approximately 22°C.
- When the THERMOSTAT Control switch is set at positioned at "10", the room-side fin coil may freeze up and prevent effective cooling. If this happens, turn the switch to "FAN", and turn the THERMOSTAT Control switch counterclockwise.

REVERSE CYCLE MODEL

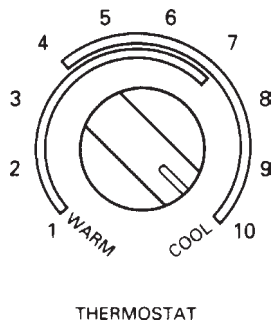

CAUTION!

When cooling/heating is stopped by means of either the MASTER CONTROL or THERMOSTAT Control switch do not restart cooling/heating for at least 3 minutes.

- If cooling/heating is restarted within this time, the compressor motor will be subjected to an over current and a compressor motor safety device will be actuated. If this occurs, restarting cooling/heating will not be possible for about 20 minutes.

AIR DIRECTION ADJUSTMENT



WARNING!

- Do not put fingers or other objects into the air louvres; an internal fan operates at high speed and could result in personal injury or damage.
- Do not operate the air conditioner with the airflow louvres blocked, since malfunction could result.

Vertical Adjustment

Up-Down Airflow-direction Louvres

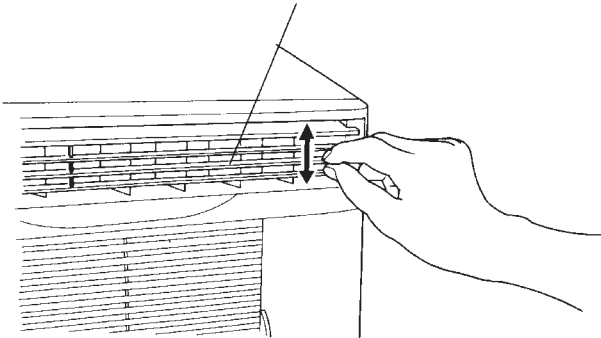

The Up-Down Airflow-direction Louvres may be positioned using tabs to discharge the air upward, downward or straight on.

Horizontal Adjustment

Right-Left Airflow-direction Louvres

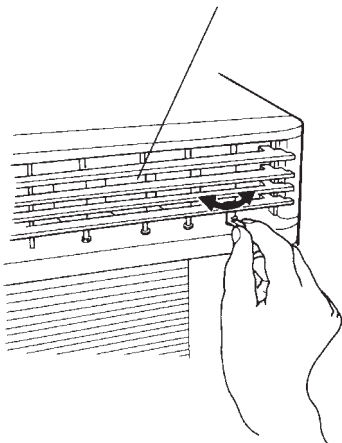

The Right-Left Airflow-direction Louvres may be positioned using tabs to discharge the air rightward, leftward or straight on.

NOTE:

The THERMOSTAT positions "8", "9" and "10" can be used when the room temperature does not become sufficiently low. This condition may occur when the THERMOSTAT Control switches off automatically because cooled air, when it passes through the Up-Down Airflow-direction Louvres positioned downwards, makes a short circuit and the recirculated air touches the sensor of the THERMOSTAT.

CARE AND MAINTENANCE

CAUTION!

Before cleaning the unit, be sure to stop the unit and disconnect the power supply.

1. Disconnect the power plug.
2. Turn off the electrical breaker.

- A fan operates at high speed inside the unit, and personal injury could result.

Cleaning the Air Filter

If dirt is allowed to collect in the air filter, the airflow will be reduced, leading to reduced performance, and increased operating noise. Be sure to clean the filters at the beginning of the operating season, and about every two weeks during periods of frequent operation.

Remove the Air Filter:

Remove the Air Filter from the front panel assembly by pulling rightward.

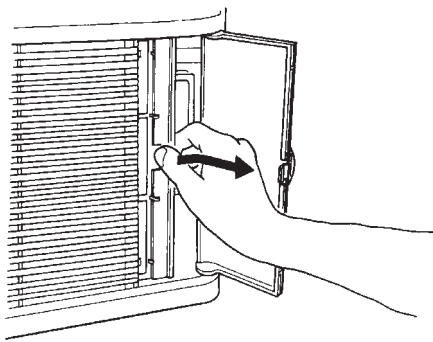

Cleaning

Use a vacuum cleaner to remove dust and dirt from the air filter, or wash in a synthetic detergent. After washing, dry in a shaded place, then reinstall.

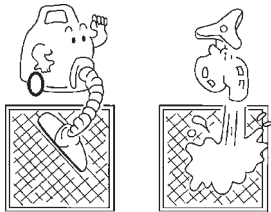

Installing the Air Filter

Hold the air filter by its handle, and insert into the front panel, then press in fully to the handle.

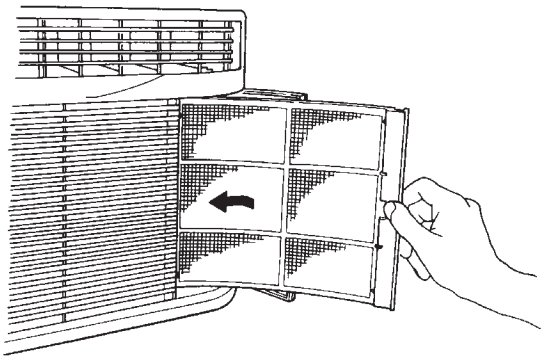

Inspections and Repairs

Depending on the conditions of use, the internal parts of an air conditioner will become dirty after about two or three seasons of use, and performance may be affected. For this reason, regular professional maintenance is recommended. Consult authorized service personnel.

Cleaning the Indoor Unit

Clean the indoor unit by wiping with a cloth dipped in cool or warm water, then wipe with another soft, clean, dry cloth.

CAUTION!

Never use water that is hotter than 40°C. The body may warp or change colour.
Do not use inflammable sprays such as lacquer or hair spray near the air conditioner.
The unit can be damaged by gasoline, benzene, thinners, insecticides and other chemical agents.

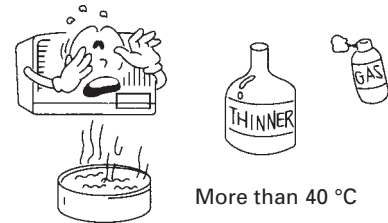

When Not Using the Unit for Extended Periods (One Month or More)

Operate the unit on fan mode for about one-half day on a day with clear weather, to assure that the internal parts are dry.

CAUTION!

When not using the unit for extended periods, disconnect the power plug for safety.

- When a plug is left connected, dust may collect on the blades, leading to smoke and fire hazard.

Check the Power Cord

Check the power cord occasionally to confirm that it is not damaged by cuts or abrasions. If you discover damage to the cord, consult authorized service personnel.

TROUBLESHOOTING





WARNING!

In the event of a malfunction (burning smell, etc.), immediately stop operation, disconnect the power plug, and consult authorized service personnel. Merely turning off the unit's power switch will not completely disconnect the unit from the power source. Always be sure to disconnect the power plug or turn off your circuit breaker to ensure that power is completely off.

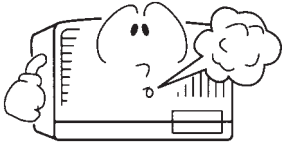
Before requesting service, perform the following checks:

	Symptom	Problem
NORMAL FUNCTIONS	Noise is heard: 	<ul style="list-style-type: none"> ● During operation and immediately after stopping the unit, the sound of water flowing in the air conditioner's piping may be heard. Also, noise may be particularly noticeable for about 2 to 3 minutes after starting operation (sound of coolant flowing). ● During operation, a slight squeaking sound may be heard. This is the result of minute expansion and contraction of the front cover due to temperature changes. ● During Heating mode, a sizzling sound may be heard occasional. This sound is produced by the automatic defrosting operation. (Heating)
	Smells:	<ul style="list-style-type: none"> ● Some smell may be emitted from the air conditioner. This smell is the result of room smells (furniture, tobacco, etc.) which have been taken into the air conditioner.
	Mist or steam are emitted: 	<ul style="list-style-type: none"> ● During Cooling operation, a thin mist may be seen emitted from the indoor unit. This results from the sudden Cooling of room air by the air emitted from the air conditioner, resulting in condensation and misting. ● During Heating operation, the fan may stop, and steam may be seen rising from the unit. This is due to operation of the defrosting mode. (Heating)
	Airflow is stop.	<ul style="list-style-type: none"> ● During Heating mode, the unit will temporarily stop operation (between 6 and 12 minutes) as the automatic defrosting mode operates. During defrosting operation, the OPERATION indicator lamp will flash slowly. (Heating)

	Symptom	Items to Check
CHECK ONCE MORE	Doesn't operate at all: 	<ul style="list-style-type: none"> ● Is the power plug disconnected from its outlet? ● Has there been a power failure? ● Has a fuse blown out, or a circuit breaker been tripped? ● Is the MASTER CONTROL switch set to the OFF position?
	Poor Cooling (or Heating) performance: 	<ul style="list-style-type: none"> ● Is the air filter dirty? ● Are the air conditioner's intake grille or outlet port blocked? ● Did you adjust the room temperature settings (thermostat) correctly? ● Is there a window or door open? ● In the case of Cooling operation, is a window allowing bright sunlight to enter? (Close the curtains.) ● In the case of Cooling operation, are there heating apparatus or computers inside the room, or are there too many people in the room?

If these checks do not rectify the problem, stop operation, disconnect the power plug, and consult your authorized service personnel.

OPERATION DETAILS

Please read and understand the following details regarding this air conditioner.

Operation and Performance

Heating Performance

- This air conditioner uses a heat pump which absorbs heat from outside air and brings it indoors. As a result, its heating performance is reduced as the temperature of outside air drops. If you find that insufficient room heat is produced, we recommend that you use the air conditioner together with other heating appliances.
- Heat-pump type air conditioners use warm-air recirculation to warm your entire room. As a result, some time will be required after starting operation until your entire room becomes warm.

Microcomputer-controlled Automatic Defrosting

When outside air temperatures are low and humidity is high, using the Heating mode may result in the creation of frost inside the outdoor unit, lowering its heating performance. A built-in microcomputer is used to monitor this condition and when necessary, the defrosting mode operates, resulting in a temporary interruption of the Heating mode (both indoor and outside fans will stop). About 7 to 15 minutes will be required for normal operation to be resumed.

Temperature and Humidity Range

Permissible ranges of temperature and humidity are as follows:

Cooling Operation	Outdoor temperature: About 21°C to 43°C
	Indoor temperature: About 21°C to 32°C
	Indoor humidity: About 80% or less. If the unit is used for long periods under conditions of high humidity, water may condense on and drip from the surface of the unit.
Heating Operation	Outdoor temperature: About 0°C to 21°C
	Indoor temperature: About 30°C or less

If the unit is used under higher temperature conditions than those noted here, the automatic protection circuit may operate, interrupting the operation. If the unit is used under lower temperature conditions than those noted here, the heat exchanger may freeze, causing water leakage or other malfunction.

- Do not use the air conditioner for any purpose other than room cooling or room heating.